

TT-6508 8-Channel Embedded Digital Video Recorder

User's Instruction Manual



Contents

1	Introduction	4
1.1	Functions	4
1.1.1	Product overview	4
1.1.2	Main Functions.....	4
1.2	Panel and Keys.....	6
1.2.1	Indicators	6
1.2.2	Operation Keys	8
1.2.3	Ports.....	9
1.3.	Rear Panel and Ports.....	10
1.4.	Alarm Ports Output View.....	11
1.4.1	Alarm Port Pins Defination.....	11
1.4.2	Alarm connection diagram	12
1.5.	Remote Control.....	17
1.5.1	Number Keys	18
1.5.2	Menu Operation Keys	18
1.5.3	PTZ Control Keys.....	18
1.5.4	Player Keys.....	18
1.5.5	Other Keys.....	19
1.6.	Technical Specification date.....	20
2	Installations	23
2.1	Check list Accessories	23
2.2	Hard Disk Installations	23
2.3	Installation Environment.....	23
2.4	Cautions.....	24
3	System Operations.....	25
3.1	Start Up/Shut Down System.....	25
3.1.1	Start Up System	25
3.1.2.	System Log In	25
3.1.3	Shut Down System	27
3.2	System Function Setup.....	27
3.2.1	System setups	28
3.2.2	Recording Parameters	30
3.2.3	Channel Setup	31
3.2.4	General Setups	35
3.2.5	Alarm Setups	36
3.2.6	Schedule	37
3.2.7	Network Setup	40
3.2.8	PTZ Setup.....	42
3.2.9	EXIT.....	43

4	Checking Operations.....	44
4.1.	Recording Data	44
4.2.	Log Search.....	46
4.3.	Device Info.....	47
4.4.	EXIT.....	49
5	Other Operations.....	50
5.1.	CF Card Operations.....	50
5.1.1	CF Card Upgrade.....	50
5.1.2	Other Operations of CF Card	50
5.1.3	CF Card Returnup Data	51
5.1.4	CF Card Data Playback	52
5.1.5	CF Card Copy Information and Upgrade Setup	53
5.2.	CD Operations	54
5.2.1	Eject/Inject	54
5.2.2	DVD Returnup Data	55
5.2.3	DVD Data Playback	57
5.3.	Recording and Playing.....	57
5.3.1	Recording.....	57
5.3.2	Playing	58
5.3.3	Time Selected Playing	58
5.3.4	Stop Playing.....	58
5.3.5	Slow Playing	58
5.3.6	Still and Frame Advance	59
5.3.7	Fast Forward.....	59
5.3.8	Fast Reverse.....	59
5.4.	Adjustments of Analog Quantities and Motion Sensitivity.....	59
5.4.1	Adjustments of Analog Quantites	59
5.4.2	Adjustment of Motion Sensitivity	60

1 Introduction

1.1 Functions

1.1.1 Product Overview

The product is a digital video recorder, which specifically IT designed for security with embedded operating system, combining up-to-date technologies of various kinds in the field of IT, such as AV Compress/Uncompress, High Capability Hard Disk Recording, TCP/IP Net etc. Video Noise Reduction and other codes solidify in FLASH, so that the system is more stable.

With characteristics of both Digital Video and Audio Recorder (DVR) and Digital Video and Audio Server (DVS), the equipment supports both independent local work and connecting to make up a strong security surveillance net. It can be used in safety and protection of bank, telecommunication, electric power, justice, traffic, district, factory, storehouse, resource, water conservancy facilities and other fields or parts.

1.1.2 Main Functions

1.1.2.1 Compression Function

1. Support max 8ch of PAL/NTSC video signal, 25/30 fps per channel independent real time hardware compress, use enhanced MPEG-4 compression technology in video, support Variable Bit Rate (VBR) and Variable Frame Rate (VFR). Enable to set video image quality and compress code stream of video image.
2. Special video Noise Reduction enhances the definition of image effectively, and improves the coding efficiency, especially the coding efficiency during the night.
3. Support max 8ch audio signal, audio signal in each channel is independent compressed real-time, audio compression standard is ADPCM, and the compress code rate is 4KBPS.
4. Generate compound code stream after compressing video and audio signal, video and audio keep synchronous when playback. It is optional to playback without audio
5. Support adjustable dynamic parameters setting
6. Support D1, HD1, CIF resolution.
7. Support multi-region motion detection.
8. Support OSD, adjustable position of date and time, brightness/adjusting setting, automatic increase on date and time
9. Support LOGO.

1.1.2.2 Recording and Storage

1. Four modes of file recording: Timer, Manual, Motion Detection, Alarm recording.
2. Support eight IDE hard disks.
3. Special hard disk management, largely reduce the working time of hard disk, increase the service life of hard disk.
4. File system of hard disk is FAT32.
5. Cycle or non-cycle recording the files in hard disk is optional.
6. Provide Return-up and edit of the recording in hard disk, support CF card, DVDRW Returnup equipment.
7. Support USB interface, convenient for connecting to computer.

1.1.2.3 Preview and Playback Function

1. Support monitor or VGA output.
2. Multiple display mode (1/4/8) switch while preview.
3. Support partial masking on image
4. Support fast, slow, single-frame and other playback modes, and searching according to the type, or time of the event.
5. Support clock insertion.
6. Local recording status display.
7. Support single channel playback while recording with 8ch real time
8. Support video tour function

1.1.2.4 Alarm Function

Motion detection zones for each channel can be set independently, adjustable motion sensitivity, 8ch external switch input, 6ch alarm output for alarm linkage, alarm upload, and upload to the network client.

1.1.2.5 Security Management Function

User MGMT on multi-level,
Multi-password control,
Perfect log management.

1.1.2.6 Controlling Function

Compatible with multi communications protocols, control over PTZ Lens, dome camera, and matrix; compatible multi alarm interfaces communication protocols.

1.1.2.7 Network

1. Support TCP/IP protocol.
2. Support network control command, can be operated through using the remote PC
3. Real time browse the video and audio signal of any channel or max 8 channels and check video equipment status can be realized through setting parameter by network.
4. Network alarm linkage (alarm signal upload).
5. Control PTZ and Lens through network.
6. Real time record compression bite rate through network.
7. Download web disk recording files, and remote playback recording files in the DVR through network.
8. Support logs (Access Log, Alarm Log) record and search

1.1.2.8 Development Support

1. Provide soft ware development kit (SDK) of operating the Web Cam recorder.
2. Provide original code of the demonstration software, to quicken the development of application system.

1.2 Panel and Keys

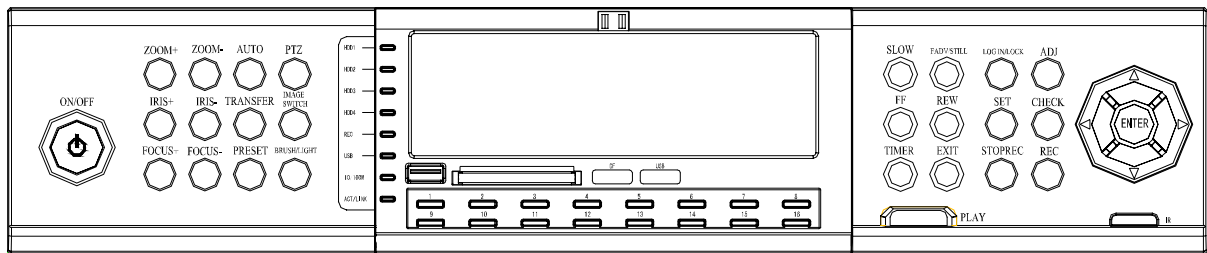

1.2.1 Indicators

- 1) LED 1-8 Indicators:

Recording indicators are corresponding to 8 channels, the indicator will be off while the channel isn't recording; the indicator will be on while recording; and the indicator will be blinking while alarm;

2) HDD 1-4: Hard Disk Indicators

Blinking while hard disk is working, off in other status;

3) LINK/ACT:

ON--Ethernet connects correctly, BLINKING--sending or receiving data;

4) 10M/100M:

Network speed indicator ON-100M, OFF-10M;

5) Recording Indicator:

ON--recording, OFF--not recording;

6) PTZ Indicator:

Indicator below PTZ Control Key is on while PTZ Control Key is activated, off while Number Keys are activated;

7) Standby Indicator:

The indicator is red while the equipment is standby, and off while working;

8) USB: On while USB is working, off while not working;

1.2.2 Operation Keys

1) PTZ and Number Control Keys

【PTZ】 Key: Changing PTZ control key, press it to enter PTZ operation status, press again to exit the PTZ operation status;

【ZOOM+】 , **【ZOOM-】** Keys: Zoom in and zoom out;

【IRIS+】 , **【IRIS-】** Keys: Adjust image brightness;

【FOCUS+】 , **【FOCUS-】** Keys: Adjust image definition;

【AUTO】 Key: Auto control;

【TRANSFER】 Key: PTZ transfer control;

【PRESET】 Key: PTZ preset control;

【BRUSH/LIGHT】 Key: Brush and light control;

【0-9】 Keys: Number keys, for number input or video channel switch, enable you to change the screen to single window screen output with number keys without menu, such as pressing 01 keys (press 1 when 0 displays) means changing to the 1st channel window screen, pressing 12 keys (press 2 when 1 displays) means changing to the 12th channel window screen

REMARK: Press double numbers to change.

2) Playing Control Keys

【SLOW】 Key: Slow play the image, 1/2x, 1/4x, 1/8x speed;

【Pause】 Key: Press to pause, press the key repeatedly, one press one frame;

【REW】 Key: Reverse to playback, Reverse 1/2 speed;

【FF】 Key: Fast forward to playback, Forward 1/2 speed;

【TIMER】 Key: For selecting time quantum while playing recording;

【EXIT】 Key: Escape from the operating menu to the surveillance image directly.

【LOG IN/LOCK】 Key: Get operating authority, namely to enter password and lock operation;

【ADJ】 Key: For adjustment of brightness, saturation and others while surveillance;

【SET】 Key: For setting parameters of the system;

【CHECK】 Key: For checking the data in hard disk;

【REC】Key: 8ch manual recording simultaneously while 8 windows screen, 4ch manual recording simultaneously while 4 windows screen, 1ch manual recording while 1 window screen;

【STOP REC】 Key: Stop manual recording;

【PLAY】 Key: Used for scan the recordings or playback.

3) Other Keys:

【ENTER】 Key: System time will display when ENTER Key or PLAY Key is selected;

▲: Upward Direction Key and Pause Key;

▼: Downward Direction Key and SLOW Key;

◀: Leftward Direction Key and REW Key;

: Rightward Direction Key and FF Key;

【ON/OFF】 Key: For system on or off (standby or on);

1.2.3 Ports

1) CF CARD: CF card slot, enable to upgrade program and Returnup data.

2) IR: Remote signal receiving window

3) USB: USB port connect to PC, download and Returnup data

1.3. Rear Panel and Ports

- (1) Power Fan
- (2) AC220V Power Input
- (3) Power Switch
- (4) Alarm Input\Output\RS-485 (refer to Alarm Port Pins Definition)
- (5) Video Signal Input:1-8ch video signal input;
- (6) Audio Output:2ch audio signal surveillance and playback output (Remark: 6508A series only)
- (7) Video Signal Input: 1-8ch video signal input;
- (8) Video Output(Commonly Referred as AV Output):2ch video signal output (Remark: 6508L series only)
- (9) VGA: Connect to computer monitor;
- (10) RS-232: Standard RS-232 port;
- (11) Network Port: RJ45 port.

1.4. Alarm Ports Output View

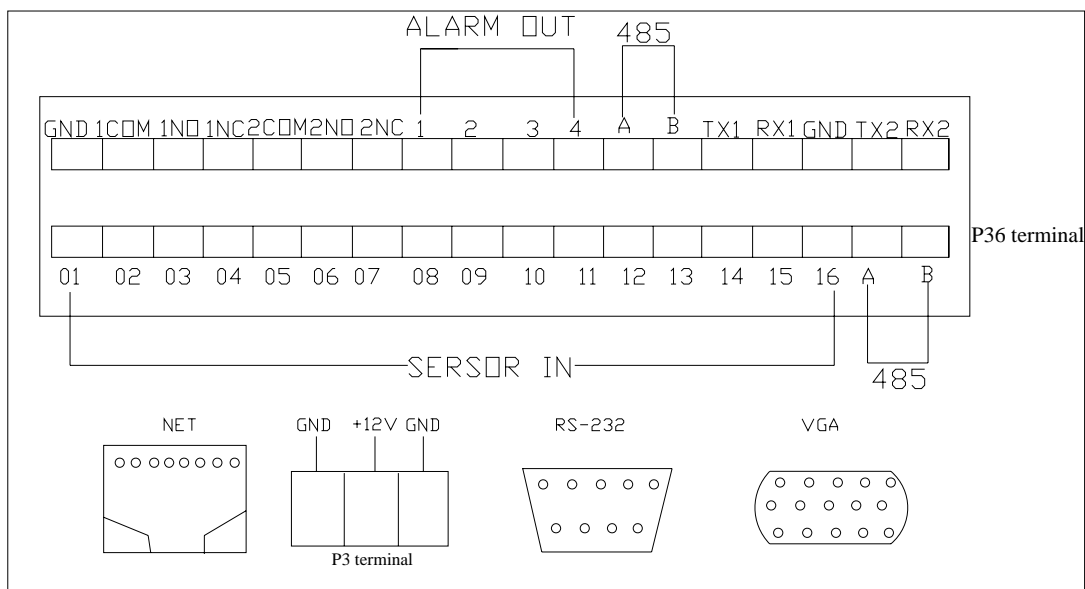

1.4.1 Alarm Port Pins Definition

Pin	Definition	Function Specification	Pin	Definition	Function Specification
Pin 1	IN1	1st Channel Alarm Input	Pin 19	GND	Grounding Pin
Pin 2	IN2	2nd Channel Alarm Input	Pin 20	COM1	Alarm Output 0
Pin 3	IN3	3rd Channel Alarm Input	Pin 21	NO1	
Pin 4	IN4	4th Channel Alarm Input	Pin 22	NC1	
Pin 5	IN5	5th Channel Alarm Input	Pin 23	COM2	Alarm Output 1
Pin 6	IN6	6th Channel Alarm Input	Pin 24	NO2	
Pin 7	IN7	7th Channel Alarm Input	Pin 25	NC2	
Pin 8	IN8	8th Channel Alarm Input	Pin 26	OUT1	Alarm Output 2 (Level Output)
Pin 9	IN9	9th Channel Alarm Input	Pin 27	OUT2	Alarm Output 3 (Level Output)
Pin 10	IN10	10th Channel Alarm Input	Pin 28	OUT3	Alarm Output 4 (Level Output)
Pin 11	IN11	11th Channel Alarm Input	Pin 29	OUT4	Alarm Output 5 (Level Output)
Pin 12	IN12	12th Channel Alarm Input	Pin 30	485A	Reservation
Pin 13	IN13	13th Channel Alarm Input	Pin 31	485B	Reservation
Pin 14	IN14	14th Channel Alarm Input	Pin 32	TX1	Reservation
Pin 15	IN15	15th Channel Alarm Input	Pin 33	RX1	Reservation
Pin 16	IN16	8th Channel Alarm Input	Pin 34	GND	Grounding Pin
Pin 17	485A	PTZ Decoder/Speed Dome A/+	Pin 35	TX2	Reservation
Pin 18	485B	PTZ Decoder/Speed Dome B/+	Pin 36	RX2	Reservation

Remark: Alarm Output 0: Corresponding to 1-8ch alarm input;
Alarm Output 1: Corresponding to DVR power break alarm

Alarm Output 2: Corresponding to 1-8ch alarm input;
Alarm Output 3: Corresponding to failure alarm;

Alarm Output 4: Reservation;
Alarm Output 5 Reservation;

1.4.2 Alarm connection diagram

1) Alarm Input Connection

(1) When alarm trigger output is switching on, DVR alarm input connection is as following;

(1.1) Set DVR alarm to normal closed (NC)

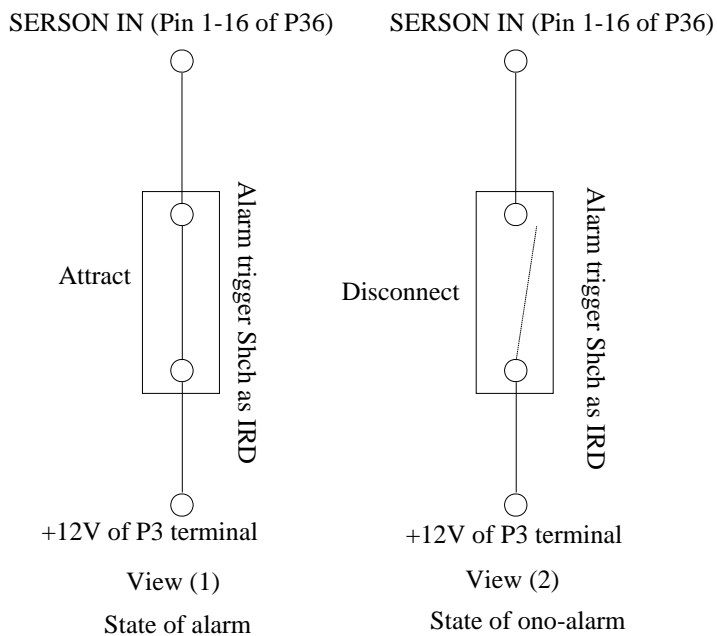

Remark: Alarm trigger is in close alarm status while the switch is closed.

(1.2) Set DVR alarm to normal open alarm (NO)

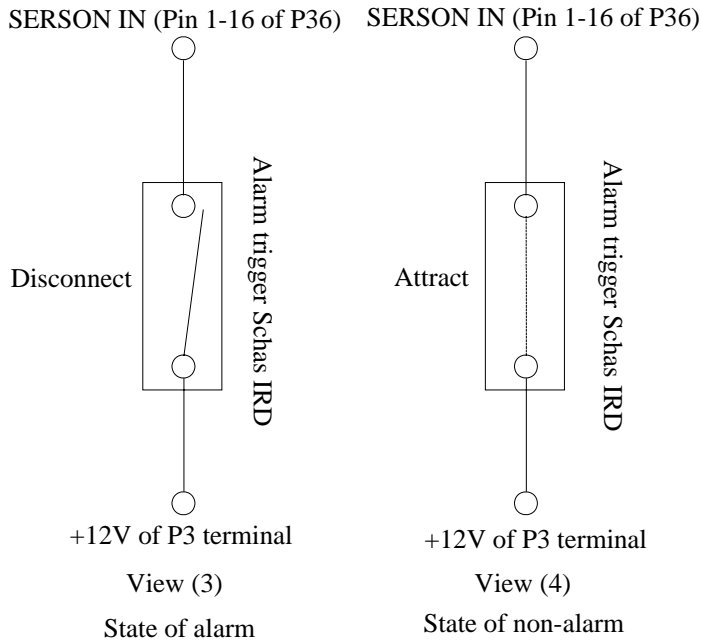

Remark: Alarm trigger is in normal open alarm status while the switch is disconnected.

(2) When alarm trigger output is level output, DVR alarm input connection is as following

(2.1) High level (5V) output while alarm trigger is in normal status, low level (0V) output while alarm, set DVR to normal open alarm (NO) at this time

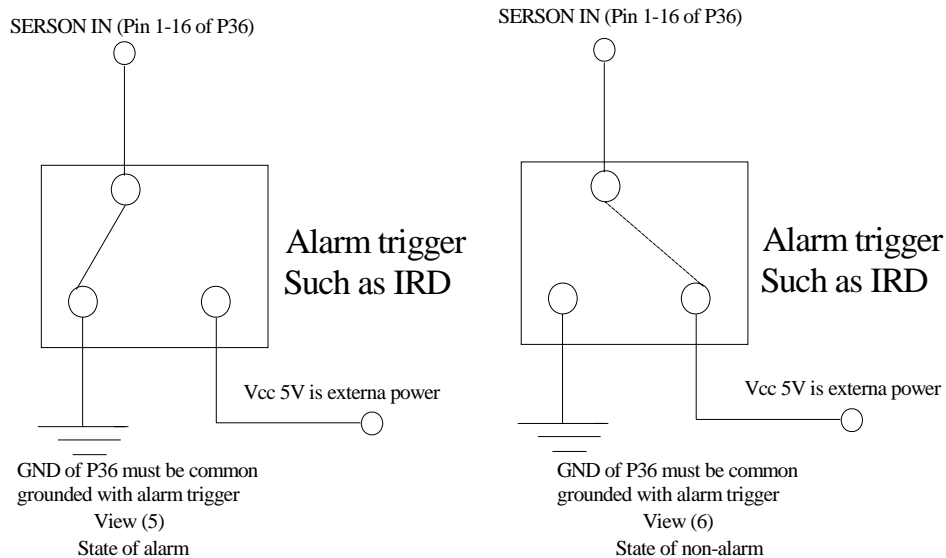

(2.2) Low level (0V) output while alarm trigger is in normal status, high level (5V) output while alarm, set DVR to normal close alarm (NC) at this time

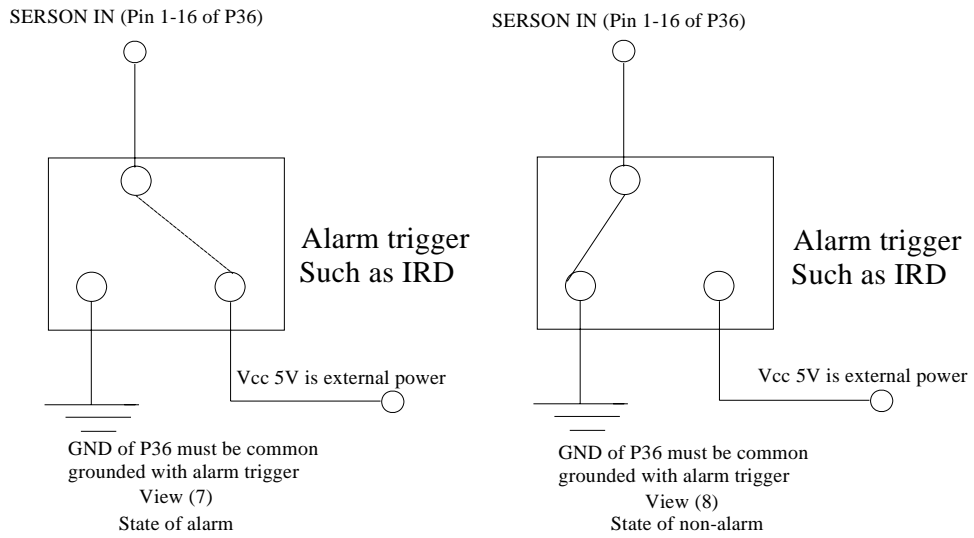

Remark: Alarm trigger must be common grounded with DVR equipment in View (5) (6) (7) (8).

2) Three connection modes of alarm output connection

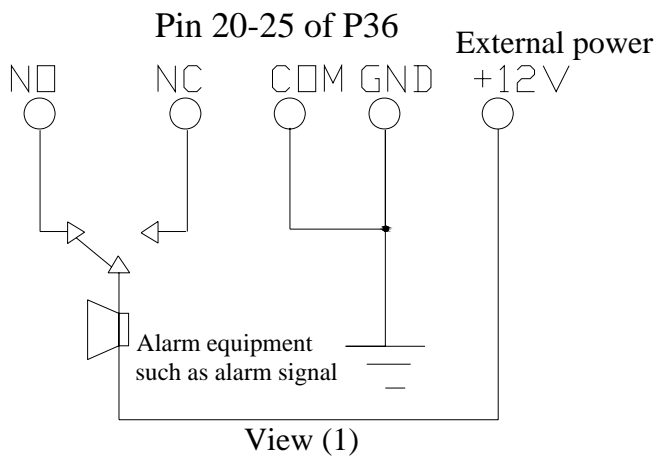

Remark: This view is alarm output connection of switch status input mode

While DVR isn't in alarm status, it is conducted between all COMs and NC, and is not conducted between all COMs and NO; on the contrary, while DVR is in alarm status, it is conducted between all COMs and NO, and is not conducted between all COMs and NC.

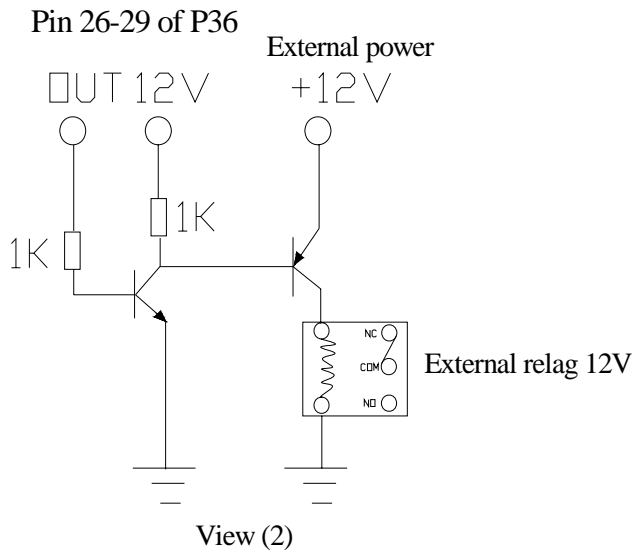

Remark: This view is alarm input connection of level output mode

While DVR isn't in alarm status, GND and OUT1-OUT4 are low level 0V, on the contrary, while DVR in alarm status, GND and OUT1-OUT4 are high level 5V

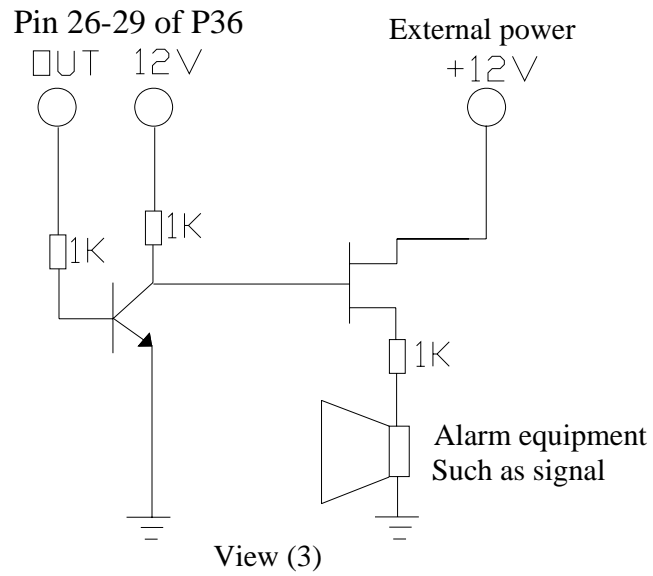

Remark: This view is alarm output connection of level input mode

While DVR isn't in alarm status, GND and OUT1-OUT4 are low level 0V, on the contrary, while DVR in alarm status, GND and OUT1-OUT4 are high level 5V

1.5. Remote Control

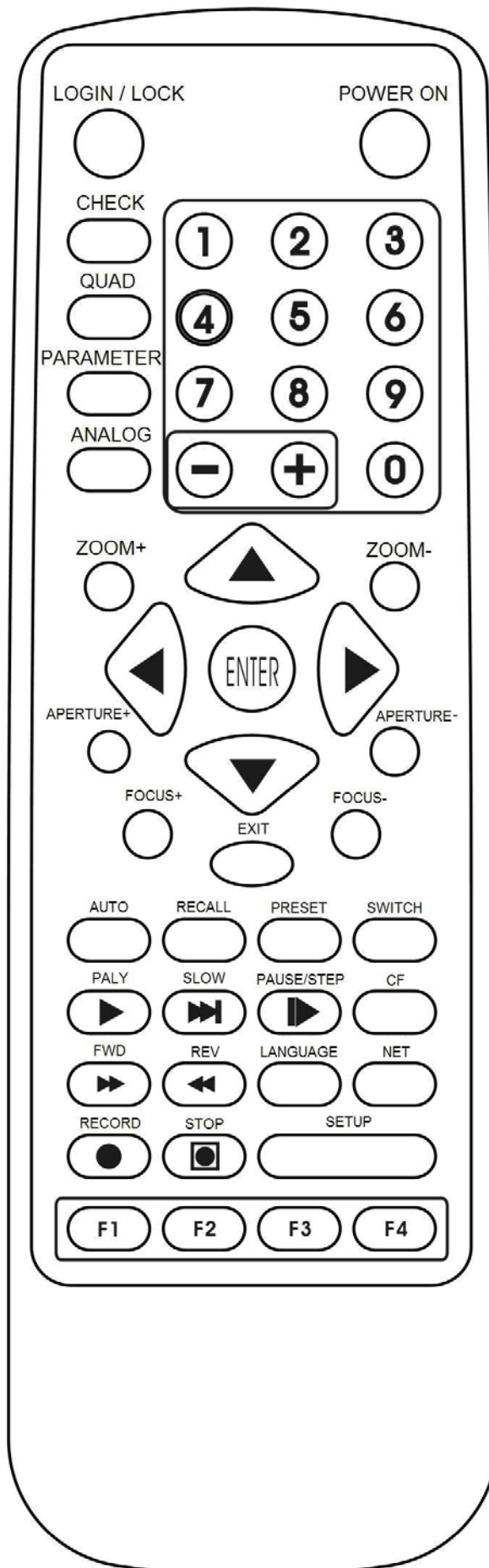

1.5.1 Number Keys

【0-9】 Keys: Number keys, for number input or video changing, press number key 1, 2, 3, 4 to change output display to the 1st, 2nd, 3rd, 4th channel single window screen of the recording while playing;

【+】 , 【-】 Keys: Adjusting analogy quantity parameters and page up or page down while searching for recording data and so on.

1.5.2 Menu Operation Keys

▲: Upward Direction Key;

▼: Downward Direction Key;

◀: Leftward Direction Key and REW Key;

▶: Rightward Direction Key and FF Key;

【ENTER】 Key: System time will display when ENTER Key is selected;

1.5.3 PTZ Control Keys

【ZOOM+】 , 【ZOOM-】 Keys: Adjust image zoom;

【IRIS+】 , 【IRIS-】 Keys: Adjust image intensity;

【FOCUS+】 , 【FOCUS-】 Keys: Adjust image definition;

【AUTO】 Key: Auto control;

【TRANSFER】 Key: PTZ transfer control;

【PRESET】 Key: PTZ preset control;

【BRUSH/LIGHT】 Key: Brush and light control;

1.5.4 Player Keys

【PLAY】 Key: Playback the recording;

【SLOW】 Key: Slow play the image, 1/2x, 1/4x, 1/8x speed; press **【PLAY】** Key to Return to normal speed;

【Pause】 Key: Press to pause, press repeatedly, one press one frame, press **【PLAY】** Key to Return to normal speed;

【FF】 Key: Fast forward to playback, Forward 1/2 speed, press **【PLAY】** Key to Return to normal speed;

【REW】 Key: Reverse to playback, Reverse 1/2 speed, press **【PLAY】** Key to Return to normal speed;

1.5.5 Other Keys

【ON/OFF】 Key: For system on or off (standby or on);

【LOG IN/LOCK】 Key: Get operating authority, namely to enter password and lock operation;

【CHECK】 Key: For checking the data in hard disk, all logs and information of the recorder;

【IMAGE SWITCH】 Key: For switching screen between multi windows and single window;

【CHANNEL PARAMETERS】 Key: For setting parameters of each channel;

【ADJ】 Key: Display the brightness, saturation, contrast, sensitivity of motion detect, adjust the parameters with **【+】** , **【-】** keys;

【EXIT】 Key: Escape to the surveillance image directly or Return to upper menu;

【CF】 Key: Press **【SET】** key to enter CF menu after insert. Select **【BASIC SET】**, enter the **【CF】** Options of the submenu and operate the CF card, details in CF CARD OPERATIONS;

【LANGUAGE】 Key: No action;

【NETWORK】 Key: No action;

【REC】 Key: 4ch manual recording simultaneously while 4 windows screen, 1ch manual recording while 1 window screen;

【STOP REC】 Key: Stop manual recording;

【SET】 Key: For setting parameters of the system;

【F1】 Key: For selecting time quantum while playback;

【F2】 Key: Press this key to enter PTZ control setting menu while single channel display.

- Press Leftward, Rightward, Upward, Downward Direction keys to make PTZ camera leftward, rightward, upward, downward adjustable, press **【ENTER】** key to auto move Return to the original position;
- Press **【ZOOM+】** , **【ZOOM-】** keys to adjust image zoom;
- Press **【IRIS+】** , **【IRIS-】** keys to adjust image intensity;
- Press **【FOCUS+】** , **【FOCUS-】** keys to adjust image definition;
- Press **【BRUSH/LIGHT】** key to control brush and light;
- Press **【AUTO】** key to control automatic;
- Press **【TRANSFER】** key to PTZ transfer control;
- Press **【PRESET】** key to PTZ preset control;

Press **【F2】** key again to escape from PTZ control setting menu;

【F3】 Key: Press **【F3】** key to change input type while setting the name of channel in channel setting;

1.6. Technical Specification data

Item	Device Parameter	Specification / details		
System	UI Language	Simplified Chinese / English		
	User Interface	Icon Operation Interface (OSD Menu)		
	Security	Multi-level Authorities, Multi-level Password		
Video	Video Input	8 Channels Independent Input with 1.0Vp-p, 75Ω BNC		
	Video Output	2ch PAL/NTSC Output with 1.0Vp-p, 75Ω BNC, Composite Video Signal 1ch VGA Display Output		
	Video Display	1/4/8 Windows per Screen		
	Video Standard	PAL 25 Frames per Second CCIR625 Lines 50Hz NTSC 30 Frames per Second CCIR525 Lines 60Hz		
	System Resource	8-ch Real Time Recording with 1ch Playback and 8-ch Surveillance, Online Real Time Surveillance		
Audio	Audio Input	8 Channels Independent Input, 600Ω RCA		
	Audio Output	2ch Surveillance/Playback Audio Output, 600Ω RCA		
	Basic Output	1.0—2.2V		
	S/N	≤-30dB		
	Recording Format	Synchronous with Video		
	Audio Compression	ADPCM		
Digital Processing and Storing	Video Compression	MPEG-4 VBR / CBR		
	Image Format	CIF (352×288 Pixels)	1/2D1 (704×288 Pixels)	D1 (704×576 Pixels)
	Video Standard	ISO14496		
	Audio Standard	ADPCM		
	Video Freq.	12.5K-93.75Kbytes/s	25K-175Kbytes/s	25K-250Kbytes/s

	Audio Freq.	4Kbytes/s		
	Audio Size Rate	14.4Mbytes/hour		
	Video Size Rate	45M-337.5Mbytes/hour	90M-630Mbytes/hour	90M-900MMbytes/hour
	Storage	8 IDE Hark Disks, Support 300G or Larger		
	Image Quality	8 Adjustable Levels		
	Max Frame Rate	25 Frames/second/channel	12.5 Frames/second/channel	6.25 Frames/second/channel
	Resolution	Playback (352×288 Pixels) Real Time Surveillance (704×576 Pixels) VGA Output (720×576 Pixels)	Playback (704×288 Pixels) Real Time Surveillance (704×576 Pixels) VGA Output (720×576 Pixels)	Playback (704×576 Pixels) Real Time Surveillance (704×576 Pixels) VGA Output (720×576 Pixels)
	Data Capture	All duplex		
Alarm	Motion Detect	Independent Setting with Each Channel, with 192 Detect Region for Each Channel and 16 Levels Sensitivity		
	Input	8ch Independent Alarm Input (8ch Level Input)		
	Output	6ch Independent Alarm Output [4ch Level, 2ch Relay Switch Status Output (24VDC /120VAC, 1A)] 1ch Power Failure Alarm Output (Relay), 1ch Other Failures Alarm Output		
	Alarm Input Mode	Open/Close		
Com Port	Serial Port	RS485 Signal, Enable to Connect with the PTZ Decoder without External Converter		
	Serial Port	RS232, Common Serial Port		
	Network Port	RJ-45 10M/100M Broadband Port		
	Network Protocol	Support TCP/IP, UDP/IP		
	Network Transfer Mode	Dial-up, ADSL, ISDN, LAN, MAN		
	Browser	Client Soft		
Others	Power	AC 220V (±20%), 50Hz (±2%)		
	Consumption	35W (without Hard Disk)		

	Working Temperature	0-50°C
	Working Humidity	≤80%
	External Dimensions	440(W)×90(H)×420(D)mm (without Footpads and Pedestal)
	Weight	14KG (with Hard Disk)
	Clock	Build-in System Clock and Calendar

2 Installations

Precaution: Before connecting the Digital video recorder to other equipments, please make sure the power is cut off, and no hot plugging.

2.1 Check the Equipment and Accessories

When you receive the product, please check according to the “Digital Video Recorder Packing List” inside the packing case.

2.2 Hard Disk Installations

Remove the screws from the upper cover of the equipment first, remove the cover, take apart the hard disk installation bars, take out the hard disk screws from the accessory box, fix the hard disk to the installation bars, and please install the hard disk strictly according to the requirements as follows:

1. The working sequence of four IDE interfaces on main board is: IDE1→IDE2→IDE3→IDE4, from left to right;
2. When you install or increase hard disk, please install according to the order as follows:
First hard disk connects to IDE1, set as master; second hard disk connects IDE1, set as slave;
Third hard disk connects to IDE2, set as master; fourth hard disk connects IDE2, set as slave;
Fifth hard disk connects to IDE3, set as master; sixth hard disk connects IDE3, set as slave;
Seventh hard disk connects to IDE4, set as master; eighth hard disk connects IDE4, set as slave;

2.3 Installation Environment

The embedded digital video recorder is a precision equipment, in order to use the video recorder safely, get satisfying performances, and increase of service life, when user selects video recorder installation environment please think about the factors fully as follows:

1. The input power of the video recorder is AC220V, be sure the outlet is AC220V. Do not plug in high voltage outlet AC380V!
2. Please do not put the video recorder in damp places or places exposed to rain.
3. Be sure the video recorder is placed and installed in a horizontal position.
4. Avoid places affected by strong vibration.
5. Do not expose the video recorder to direct sunlight, or close to heating source and high temperature environment.
6. Before video recorder installation, keep the rear panel more than 15cm from other objects or wall, for fan to well-ventilate.

7. Do not store chemical substances which may produce aggressive gas in the video recorder installation place to avoid being affected to shorten the service life of the video recorder.
8. Avoid dusty places, keep the environment clean.
9. Make sure the video recorder is grounded correctly while using the video recorder.
10. Make sure to connect to other equipment correctly while installation.

2.4 Cautions

1. Never touch the power and the video recorder with wet hands.
2. Never spill liquid on the video recorder to avoid short-circuits and causing fire.
3. Never stack other objects on the video recorder.
4. Use soft dry cloth to clean the video recorder, never use chemical solvents.
5. When the power cord is plugged in the outlet, even if the video recorder doesn't start, there is voltage inside.
6. If you do not use the recorder for long time, you'd better cut the power completely and remove the power cord from the outlet.

Remark: The video recorder is in conformity with the requirements of the national electromagnetic radiation standards, no electromagnetic radiation harm to the human body.

3 System Operations

3.1 Start Up/Shut down System

3.1.1 Start Up System

Connect power cord to outlet **AC220V**, switch on, system is standby, Standby indicator is red. Press **【ON/OFF】** key on the front panel or remote control, system is on, 8ch surveillance image display on the monitor when Standby indicator is off, the status of multi hard disks and CF card displays on the centre of the screen (if no hard disk, system will buzz), and disappears after a few minutes; after system current time (e.g.: 2006-04-10 08: 50: 02) displays on the middle of the top screen in two or three minutes, “100” characters will display on the top right corner of the screen (the set time of system logout), and start to count down, when count down to “0”, the number will change to red and blinking “LOCK” characters, the system is locked at this time.

Remarks: If local recorder has been set to timer recording, and connect to the power when it is the set time quantum to record just right, the recorder will enter multi windows screen status directly without pressing the Standby key to start the recorder.

If you start the recorder without installing hard disk, or the hard disk that has been installed is undetected in the preliminary stage of starting up, buzzer of the digital video recorder will alarm, logging in the system can clear the alarm.

If no current system time displays on the screen, please press the **【ENTER】 key on the remote control or panel and it will appear at once**

3.1.2. System Log In

After the unit starts up, you have to log in first before operating the system. No operation after log in during the logout time, the system will be locked

The landing interface is as follows:

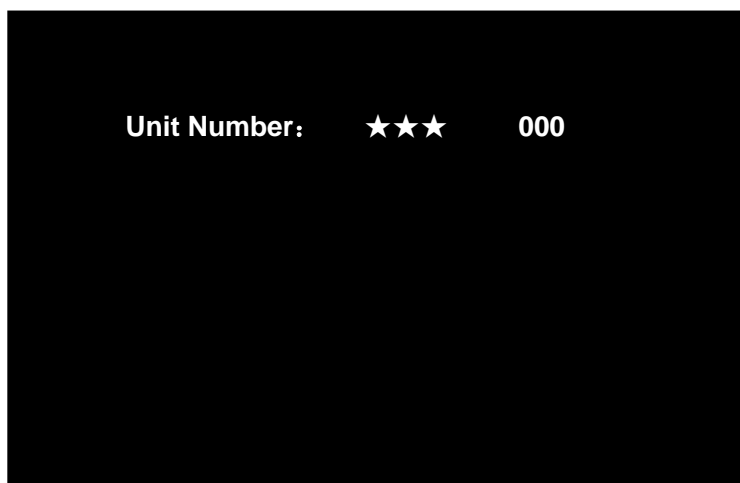

When the recorder just starts or is locked, press **【LOG IN/LOCK】** key on front panel or remote control, tips: “Unit Number: *** Unit Number: 000” display on the screen as the view above, the right 『Unit Number』 are the set recorder code of the system, left 『Unit Number』 require the user to input the same code as the recorder code on the right. User shall input: “000” as the view above, if input correctly, the system image will change as follows:

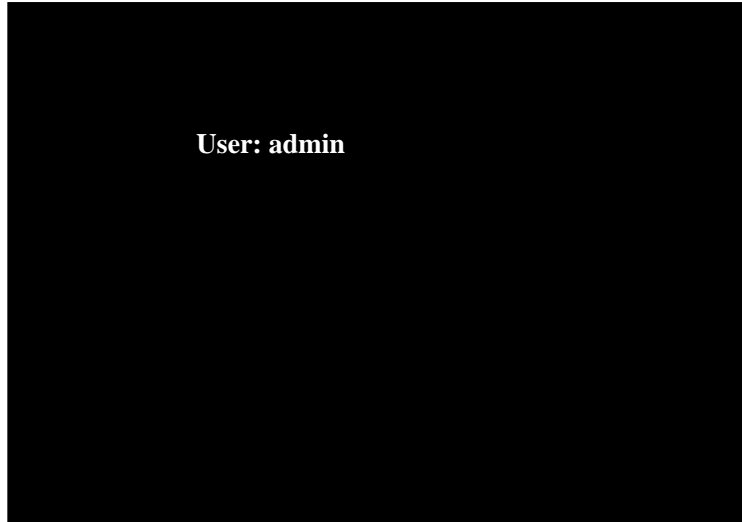

The screen above is the image of user identity confirmation, user can choose the assigned user's code of his own, 『User's Code』 is admin, user1 to user9. Admin is the default administrator, and the identity is fixed, user cannot modify it; user1 ~ user9 are common operators, every operator has the 『System setups』 authority and can define every user's authorities in the 『Users Management』 menu in 『System setups』. During initialization of the system, only admin is in effect, others shall be set.

User presses “+” “-”keys on the remote control to select user's code, press ENTER key to confirm, after being confirmed, the system will display as the view as follow: Please Enter Password. E.g.: log in with the identity of administrator, after selecting the user's code “admin”, enter the password with pressing other keys (the system default password of the administrator is: 88888888).

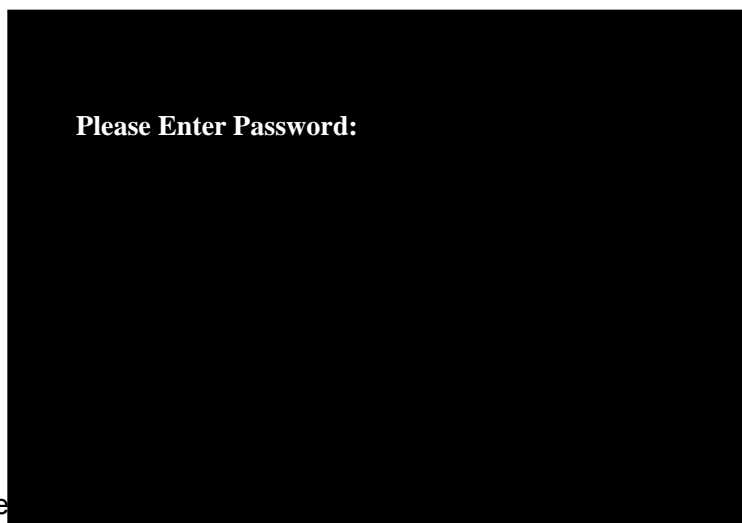

① If you enter "Incorrect" will display on the

screen, and you can operate the system in all allowed authorities of the user's level.

- ② If you log in with the identity of the administrator, enter the right administrator's password, "Administrator's Password Is Correct" will display on the screen, and you can operate the recorder in all authorities (the system original password of the administrator is: 88888888).
- ◆ **After you enter the right password, the down-count numbers on the top right corner of the screen will change color from red to green, you can operate the system at this time. Every time you return to the surveillance interface from the Setup interface, the green clock on the top right corner of the screen will restart to count down according to the set time of system logout. When the timer counts down to 0, the system is auto locked. The red timer on the right corner of the screen starts to count down, when count down to 0, the number will change to red and blinking "LOCK" characters, the recorder operation is locked. When the system is locked, you have to log in again to operate the system.**

3.1.3 System Shut Down

If you want to shut down the system, please press the 【ON/OFF】key on the front panel or remote control twice, and the system will be shut down; the system will change from the running state to the standby state, standby indicator is on; if you want to restart the system, please press the 【ON/OFF】 key on the front panel or remote control.

Remark: Please confirm the status of the system before cutting the power, normally, only cut the power when the system is shut down. So if the system is in the recording, playing, system setup and other status, please stop the current operations, and you shall cut the power after confirming the video recorder is off.

3.2 System Function Setup

System Functions interface includes functions as follows:

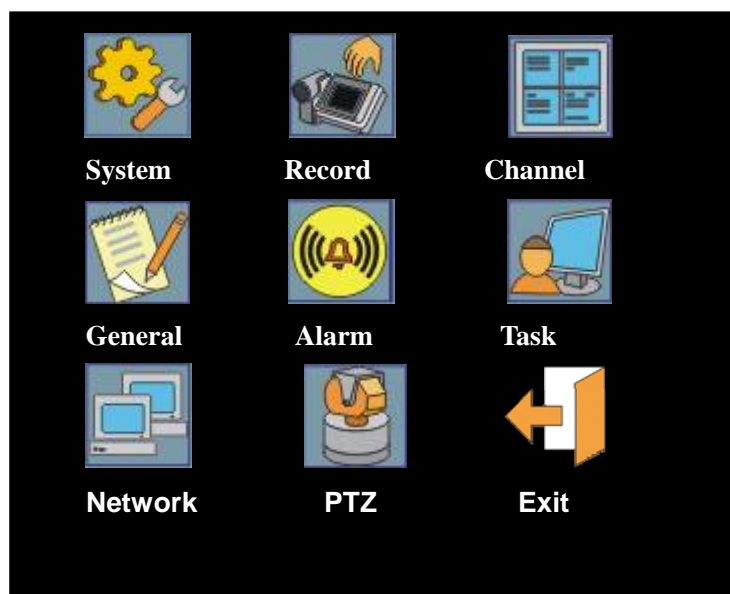

The Screen above is OSD main menu of the unit, operate the "▲, ▼, ◀, ▶" keys on the remote

control or the panel, select the icon you need (when the icon is selected, the characters below the icon will change into reverse characters), press 【ENTER】, enter the corresponding Setup, that will be introduced detail by detail as follows.

3.2.1 System setups

Move the cursor to 『System setups』 item (reverse characters mean the item is selected), press 【ENTER】 to enter setting interface of the item, after entering the submenu, move the cursor upward or downward to the item you need to modify. System setups interface is as follows:

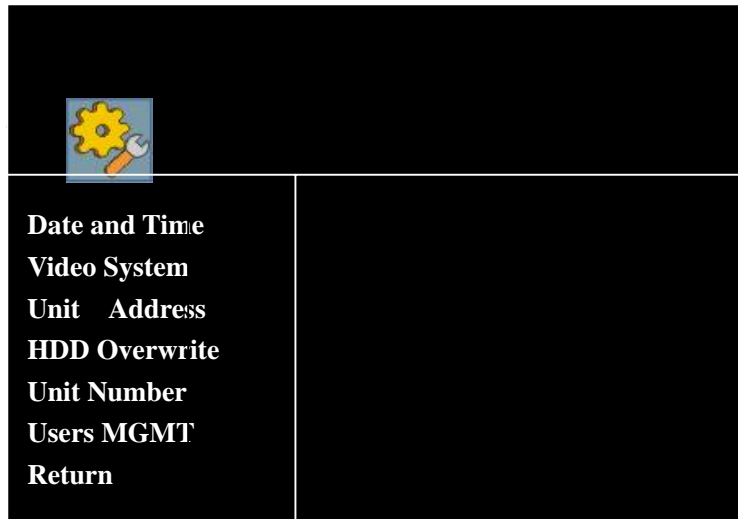

Press direction keys to the item you need, press 『ENTER』 to the Setup menu.

■ Date and Time:

You can modify every item of Year, Month, Day, Hour, Minute, Second, 『Week』 is auto modified by the system according to the date you set; move cursor to the corresponding item, press 【ENTER】 to modify or input number to modify directly. While using the number keys to modify the date, you shall only input the last two numbers.

■ Unit Number:

The input range is: any three figures between 000 ~ 999, the factory setting is 000.

■ Unit Address:

Input with the **pinyin, capital letter or lowercase letter input methods**, the way is to move the cursor to the item first, press 【ENTER】, enter input status, press 【F3】key on the remote control to switch the input method. After finishing input, press “ENTER” key again to escape from the input status.

Remark: The input max character size is 8 characters.

■ HDD Overwrite:

Press the direction keys to HDD Overwrite, press 『ENTER』 to the item: Start or Close.

■ **Video Signal System:**

PAL and NTSC, press direction keys to the Unit Number, press 『ENTER』 to enter the item, move the cursor to the corresponding item, press 『ENTER』, the item will display “☆”

■ **User Management:**

The User Management function is to manage all users of the recorder, such as Password Function On/Off (only for setting password when start up the recorder), user's authorities and others, the Users Management interface is as follows:

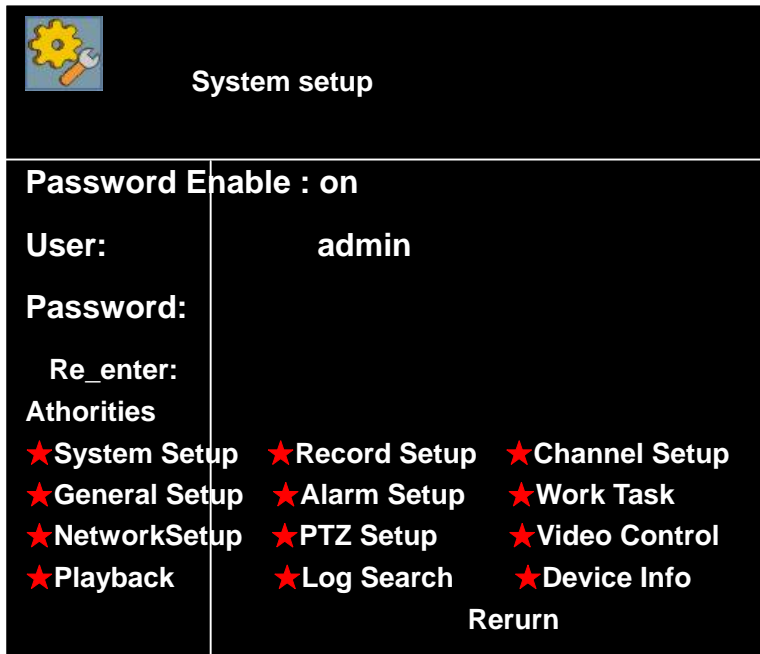

◆ **Password Function:** As the screen above, move the cursor to 『Password Function』, press 『ENTER』 to select On or Off.

◆ **User's Name:** admin, user1 ~ user9 all together 10 users' name can be set, the system supports 10 users most, admin user is the default administrator, has all authorities, and the authorities of it cannot be modified; user1 ~ user9 are common users, users with “System setups” authority can assign the authorities of their own.

Remark: Only “admin” is in effect during the initialization of the system, user1 ~ user9 need the user to enter the item with the administrator identity (admin identity), add and assign the authorities by himself.

◆ **Password:** Input any 8 characters of numbers as the user's password.

◆ **Password Confirmation:** Input 8 characters of numbers of the item above again, confirm the user's password to avoid user's wrong input.

◆ **Authorities Management:** The authorities can be set are:

System setups Recording Parameters Channel Setup

General Setups	Alarm Setups	Schedule
Network Setups	PTZ Setup	Video Controlling
Recording Data	Log Search	Device Info

Total 12 items, different authorities can be assigned according to the different users' usual work. Operating method is: Move the cursor to the corresponding item, press 『ENTER』, the item will display “☆”, meaning that authority has been assigned to the user

After setting return to the user's password and authorities, move the cursor to 『Return』 and press 『Enter』 to save and the upper menu.

3.2.2 Recording Parameters

Recording Parameters Setup include some setting of the channel, move the cursor to 『Recording Parameters』 item (character background color turning white means

the item is selected), press 【ENTER】 to enter setting interface of the item, after entering the submenu, move the cursor upward or downward to the item you need to modify.



- **Channels:** there are 01 to 8 and All 17 choices, press “+”, “-” or 【ENTER】 on the remote control to select.
- **Recording:** 『Effective/Ineffective』 two choices can be selected, if 『Effective』 is selected, recording has been set in **Schedule**, so recording is on namely it is effective.
- **Image Quality:** “1-8” total 8 levels. Move the cursor to the item needed, press 【ENTER】 to modify the **parameter** of the item, the smaller the number is, the better the image quality is.
- **Frame Rate (fps):** For NTSC, there are 02, 04, 08, 15, 30 five frame rate; For PAL, there are 01, 03, 06, 12, 25 five frame rate; press “+”, “-” or 【ENTER】 on the remote control to select.
- **Resolution:** “D1, HD1, CIF” three levels can be set. Move the cursor to the item needed, press 【ENTER】 to modify the parameter of the item

D1 (704*576): Reach the resolution of DVD image;

HD1 (704*288): Reach the resolution of SVCD image;

CIF (352*288): Reach the resolution of VCD image.

- **Bit Rate:** Move the cursor to the item needed, press **【ENTER】** to switch the Bit Rate while system is recording: VBR, CBR.

VBR: Variable bit rate

CBR: Committed bit rate

Audio: On/Off can be set;

Select Return, Return to the upper menu;

Remark: Frame Rate (fps), resolution, Encoded Mode three items are set by group, (while PAL, channel 1-8: every four channels a group, first group: 1-4, second group: 5-8. Frame rate, resolution, encoded mode of every channel in a group is the same. After setting the parameters in the interface, judgments should be done as follows:

PAL: D1 Total resource of every group is ≤ 25 frames

HD1 Total resource of every group is ≤ 50 frames

CIF Total resource of every group is ≤ 100 frames

NTSC: D1 Total resource of every group is ≤ 30 frames

HD1 Total resource of every group is ≤ 60 frames

CIF Total resource of every group is ≤ 120 frames

Remark: When two channels of D1 or HD1, only channel one and two are in effect

3.2.3 Channel Setup

Channel Setup include some setting of the channel, move the cursor to 『Channel Setup』 item (characters background color turning white means the item is selected), press **【ENTER】** to enter setting interface of the item, after entering the submenu, move the cursor upward or downward to the item you need to modify. Channel Setup interface is as follows



- **Channel:** Press keys of number or ENTER or +/- keys to select any item among 01-8 or "All".
- **Name:** Screen Display name, you can input characters with different input method, move the cursor to the item first, press **【ENTER】**, and the interface will change as follows:

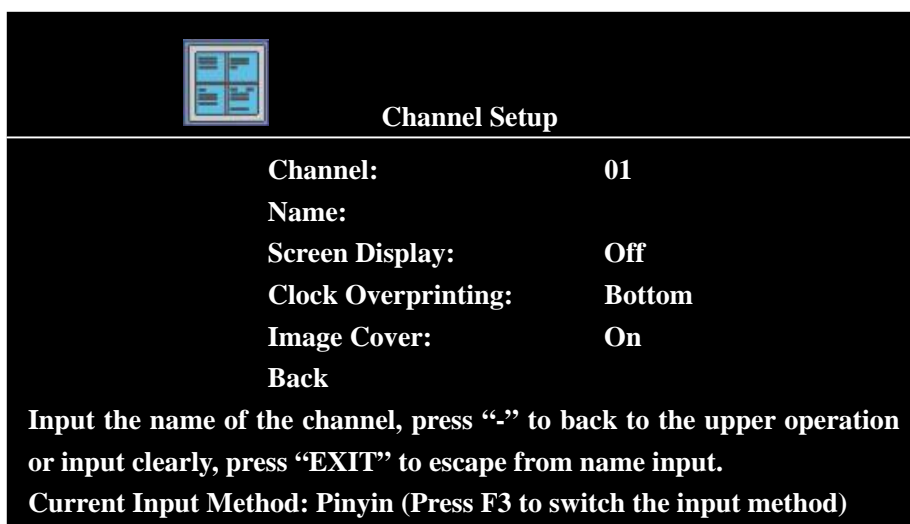

The default input method is pinyin, if you want to change, press **【F3】** to switch the input method on the remote control, and press number keys on the remote control or front panel to finish. Number keys have abundant meanings. There are different contents Remarks if you press the same number with different input method (It is similar to mobile phone input method that we are familiar with.)

If you use the pinyin input method [Current Input Method: Pinyin (Press F3 to switch the input method)]:

If you press number key 1, tips at the lower part of the screen are as follows:

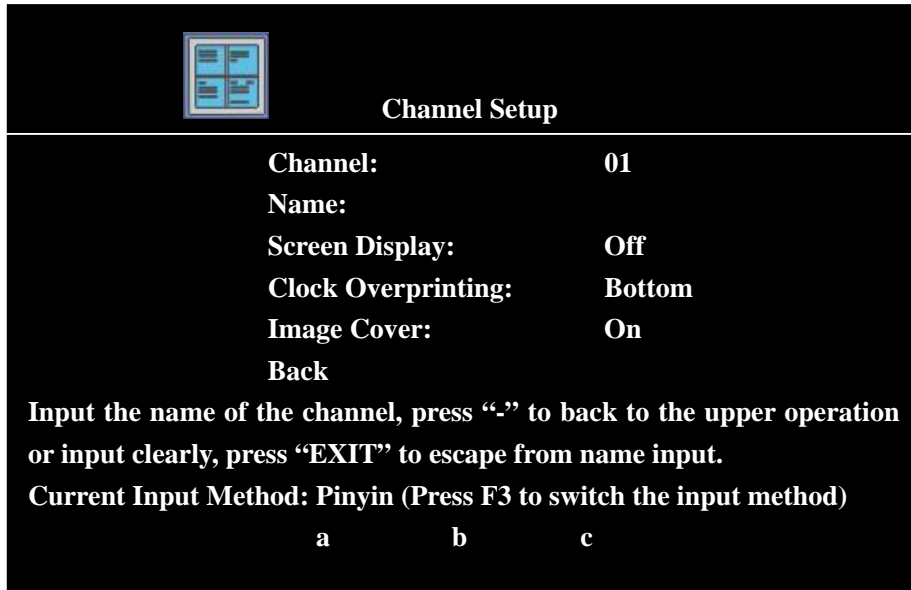

Press a (move cursor to a, press **【ENTER】**), tips will show as follows:

As follow, press different number key to select different content. And “>“means it will show more contents Remarks if you press right key. And “<“means press left key to Return to the upper interface. If you select 2 at the view below, “**啊啊**“ will automatically display in the name bar. Press “EXIT” to exit and do the same operation to select different input methods, and input different contents.

Remark: Press “-” to return to the upper operation or input clearly, press “EXIT” to exit from name input.

Max character size of input name is 8 characters.

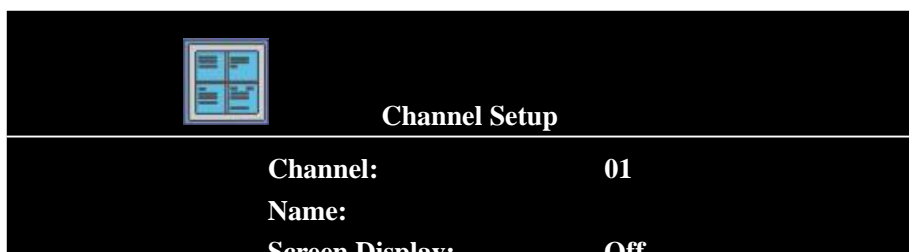

- **Screen Display:** 『On/Off』 two choice for user, when 『On』 is selected, channel's name will display on the surveillance image; if it is closed, channel's name won't display on the surveillance image. Time Insertion
- **Time Insertion:** 『Upper ON/Lower ON/Off』 three choices for user; when 『Upper ON』 is selected, time will be overprinted on the upper of the image of the corresponding channel by the system; when 『Lower ON』 is selected, time will be overprinted at the lower of the image of the corresponding channel by the system; when 『Off』 is selected, time won't be overprinted on the screen.

Remark: The system will overprint the time to the code off corresponding channel, namely, the time information overprinted to the channel, can't be seen on the surveillance image. Only when play returns the recordings, the time information overprinted can be seen.

If user need to see the system time in the surveillance status, please press 『ENTER』 on the remote control or panel of the unit, the system time will display on the upper part

Image Masking: 『On/Off』 two choices for the user, press 【ENTER】 to switch between the items. Image Mask is that the fixed zone of the image in channel is Masked, in order to avoid being recorded to the image data (white shield frame instead), to satisfy the special requirements, e.g., avoiding the image of password zone of the safe box being recorded.

Remark: Image Masking only affects the code of the channel Masking namely, after Masking zone is set, the covering effect is also on the surveillance image. The covering effect will be show while play return the image data of the channel (a white shield frame is instead of the zone covered).

On the interface of 『Channel Parameters Setup』, move the cursor to the Channel item to select 『Off』 to close the channel which need to be Masked, press 『ENTER』 on the remote control or

panel, the system will switch to the single window screen surveillance mode, press 『ENTER』 on the remote control or panel again, and there is a small white square “□” will display on the center of the surveillance screen, the square is a mark of confirming the two vertexes of the cover zone. The masking method is two points positioning method, use the direction keys on the remote control or front panel, move the small white square to the position of the first vertex, press 『ENTER』 to confirm the position of the first vertex, at this time, another small white square will display on the center of the image, move the square to the diagonal position of the first vertex, press 『ENTER』 to confirm, a zone covered will appear, press 『EXIT』 to Return to the interface of 『Channel Parameters Setup』. At this time, 『Off』 of channel mask will auto switch to 『On』 item, it means setting succeed, and it is activated. Press 【ENTER】 again, it will switch to 『Off』, stop the channel masking.

Remark: 1. while set the rectangular masking zone, multi masking zones can't be set in every channel, only one continuous zone can be set.

- 2. Screen Display, Clock Overprinting is set by group, screen display and time insertion same of every channel in a group;**
- 3. Channel Image masking can be set individually.**

3.2.4 General Setups

The General Setups include some Setup of the peripheral equipment such as: hard disk, USB, CF card, DVD-RW, move cursor to the 『General Setup』 item (characters background color turning white means the item is selected), press 【ENTER】 to enter setting interface of the item, after entering the submenu, move the cursor upward or downward to the item you need to modify. The interface is as follows:

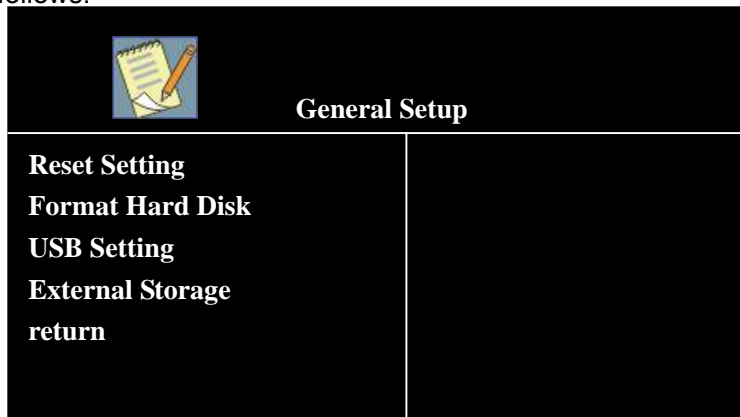

Move the cursor to 『General Setups』 item (reverse characters mean the item is selected), press 【ENTER】 to enter setting interface of the item, after entering the submenu, move the cursor upward or downward to the item you need to modify.

- **Reset Setup:** Move the cursor to the item, press ENTER to the interface of reset Setup. If you want to reset, move the cursor to the Enter item, press ENTER to reset; if you want to cancel, select Cancel item to Return to the upper menu; in addition, after reset Setup.
- **Format Hard Disk:** Format hard disk, you can select number 1-9, 9 stands for CF card, after selecting the hard disk you want to format, press Enter to the next confirm menu to format the

hard disk; press Cancel to return to the upper menu.

- **USB Setup:** Enter the setting image, 『Off/Start first group of hard disks/Start second group of hard disks/Start third group of hard disks/Start fourth group of hard disks』 five items for user, select the item, and press **【ENTER】** to confirm. If you don't want to operate the item, move the cursor to 『Return』, press **【ENTER】** to Return to the interface of 『General Setups』

Remark: After USB Setup is started, you can use DVR as a slave equipment through the USB port, connect to the PC (PC shall support USB port), copy the files and Returnup data and other operations

- **External Storage:** You can operate the CF card and CD in this interface;

TIP: Exact specifications for the functions and operations of CF card and CD are in “CF Card Upgrade and Operation and CD Operation” part of the manual.

Press Return, return to the upper menu.

3.2.5 Alarm Setups

Alarm Setups include some setting of the alarm, move the cursor to 『Alarm Setups』 item (characters background color turning white means the item is selected), press **【ENTER】** to enter setting interface of the item, after entering the submenu, move the cursor upward or downward to the item you need to modify. The interface is as page follow.

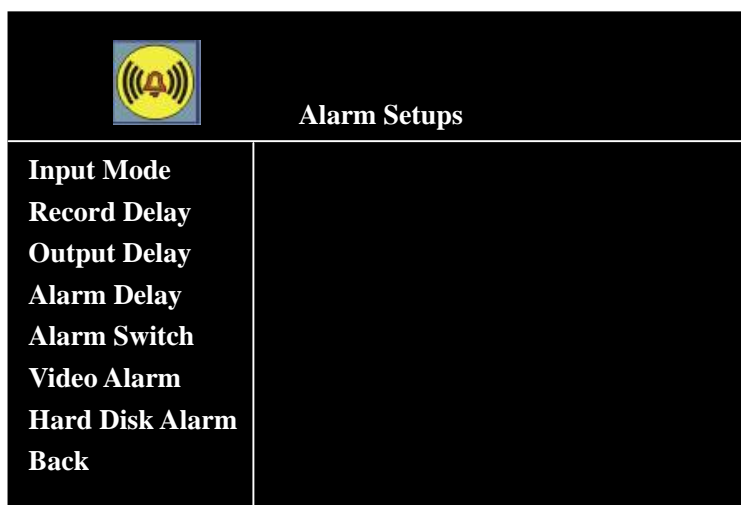

- **Input Method:** 『NO/NC』 two choices for port, two mode standing for I/O alarm input signal, set according to the external equipment which triggers alarm signal.
- **Recording Delay:** It means time span (120 ~ 300 seconds) of linkage record is adjustable when system receive alarm signal.

Tip: The setting has the same effect on the recording mode of motion alarm.

- **Output Delay:** The retaining time span in output signal state of alarm linkage status when alarm signal, if the alarm output port is connected with alarm lamp, alarm bell and other alarm

equipment. Output delay is the time span of the alarm lamp, alarm bell started.

- **Alarm Delay:** It means the time span the buzzer of the recorder buzzes when the system receives the alarm signal.

Tip: The setting has the same effect on the signal of motion alarm.

- **Alarm Switch:** Alarm controlling of the buzzer inside the recorder, “On/Off” can be set;
- **Video Alarm:** Move the cursor to the item, press **【ENTER】** to change the Setup of this item: “On” or “Off”.

Remark: “On” means: if video signal is missed when the system starts, the buzzer will alarm, and “Video Missed” characters will display on the screen; “Off” means: the buzzer won’t alarm if the video is missed, only “Video Missed” will display on the screen.

- **Hard Disk Alarm:** Move the cursor to the item, press **【ENTER】** to change the Setup of this item: “On” or “Off”. Hard Disk Alarm here means hard disk failure alarm, if the recorder isn’t connected to hard disk, no matter if this item is on, alarm will be triggered

Remark: The prerequisite of the hard disk failure alarm is that the system can find the hard disk. Triggered but if the system cannot read hard disk installed, no failure alarm will be triggered.

3.2.6 Schedule

Move the cursor to 『Schedule』 item (reverse characters mean the item is selected), press **【ENTER】** to enter the interface

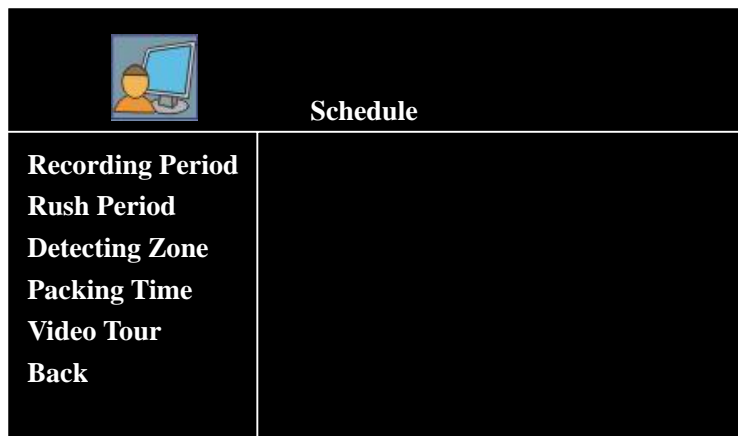

Schedule includes Setup of recording plan and the zone of motion detects of every channel, concrete operations of every item as follows:

- **Recording Period:** As the view above, move the cursor to 『Set』 item of the corresponding channel in 『Recording Period』, press **【ENTER】** to the setting interface as follow:

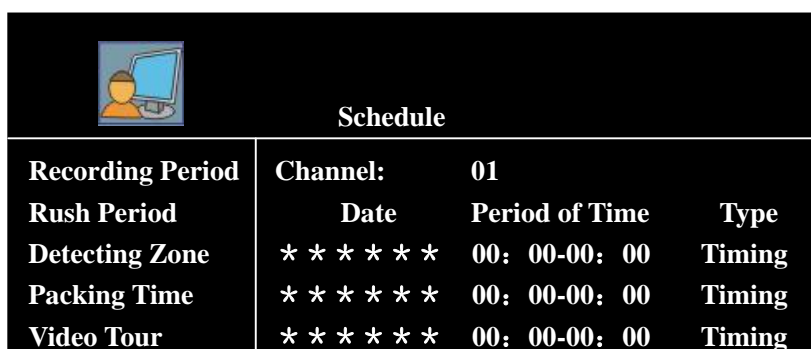

- ◆ **Channel:** Press **【ENTER】** or +/- keys to select any item among 01-8 or “All”. Select **all** to set all the 8ch.
- ◆ **Date:** 『Everyday/Monday ~ Sunday/*****』 eight choices for user, 『*****』 means no date, user can switch among the choices through **【ENTER】** or +/-.
- ◆ **Period of Time:** Set the recording period of time.

Tip: Date can be multi-item set as repeat, for satisfying requirement of multi-period recording in the same date

Remark: When you set the recording period, time in front of “——” must be earlier than the time behind “——”.E.g. Setting as follow is wrong: “13:00——11:30”.

- ◆ **Type:** 『Schedule/Motion/Alarm』 three choices for the user, press **【ENTER】** to switch among the items. 『Schedule』 means it is always recording during the period in this channel; 『Motion』 means it is video motion detection during the period, when there is object moving in the detect zone, system will start to record in a regular time, if no object moving, it won't record; 『Alarm』 means when the channel receive external I/O alarm trigger signal, system will start to record in a regular time, no external I/O alarm trigger signal, it won't record.

Remark: When you select “Motion” recording type, it can't link to multi channel to recording, no alarm linkage output at the same time, but the unit will trigger alarm signal (sound from the buzzer of the unit).

- ◆ **Copy:** Copy the Setup of current channel to another. Operation Method: Press **【ENTER】** or +/- keys to set the period of time first, select the channel needed to copy and the channel you want to copy to, then select Copy. After coping, press Return to return to the upper menu.

After setting period of time, move the cursor to 『Return』 and press 『Enter』 to Return to the 『Schedule』 interface.

- **Rush Period:** Press +/- or ENTER to select date and time, 『Everyday/Monday ~ Sunday/*****』 eight choices for user, while the rush period has been set, press power switch on the rear panel without pressing the 『ON/OFF』, namely, the system won't be standby and enter the recording status directly in the rush period (if it is set to record in this

period of time) when the power is connected

- Detect Zone: Press **【ENTER】** to enter the interface when the red cursor points to the 『Detection Zone』 , as follows

Schedule				
Recording Period	Channel	Effective zone	Channel	Effective zone
Rush Period	1	Set	9	Set
Detecting Zone	2	Set	10	Set
Packing Time	3	Set	11	Set
Video Tour	4	Set	12	Set
Back	5	Set	13	Set
	6	Set	14	Set
	7	Set	15	Set
	8	Set	16	Set
				Back

As the view above, select a channel to set. Press **【ENTER】** to enter the setting interface of Effective Zone:

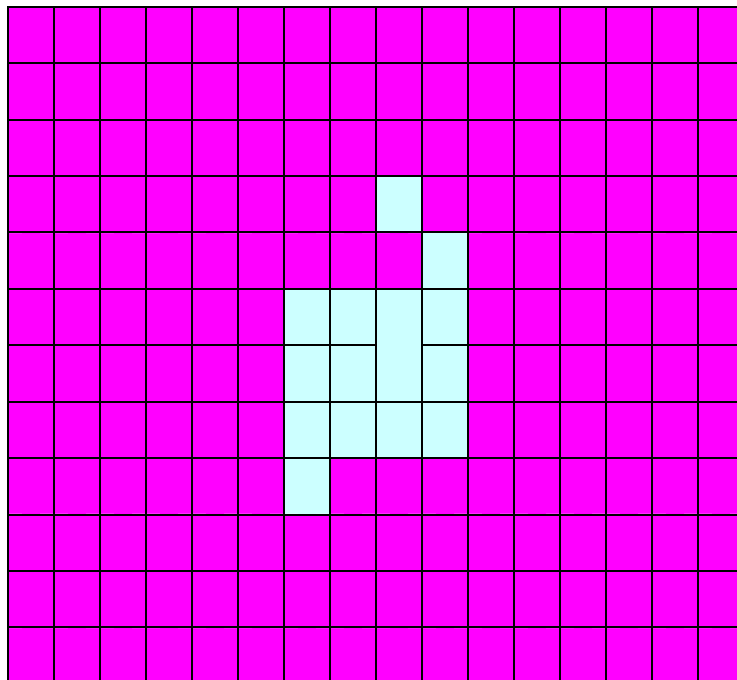

The view above is made up by 16×12 little zones. Light purple zones stand for the zones which are not selected, transparent zones stand for the zones that are selected. Operating method is: enter the setting interface, there will be a small inlaid square on the screen, press **【ENTER】** , and the purple small square will turn transparent, it means that the zone is selected, press the direction keys on the remote control or panel, the small square will move among the zones, and the zones

will be selected, press **【EXIT】** , Return to 『Schedule』 interface, zone Setup succeed.

- **Packing Time:** Move the cursor to the item needed, press **【ENTER】** to adjust, 30,45,60 minutes of packing time can be select.
- **Video Tour:** Move the cursor to the item, press **【ENTER】** to enter the interface: Tour Switch (On/Off), Tour Interval (unit: second). After confirm the video tour output on the rear panel is connected correctly (namely connect the video output port with video tour port), if tour switches on, the system will play the image of 8 channels repeat with the set interval of Tour Interval.

Remark: The time of Tour Interval is from 5 to 60, they are multiples of 5. Press **【ENTER】 , “+” “-” to adjust**

After setting, press Return or EXIT to escape from this interface.

3.2.7 Network Setups

Move the cursor to 『Network Setups』 , press **【ENTER】** to enter the interface of network ports:

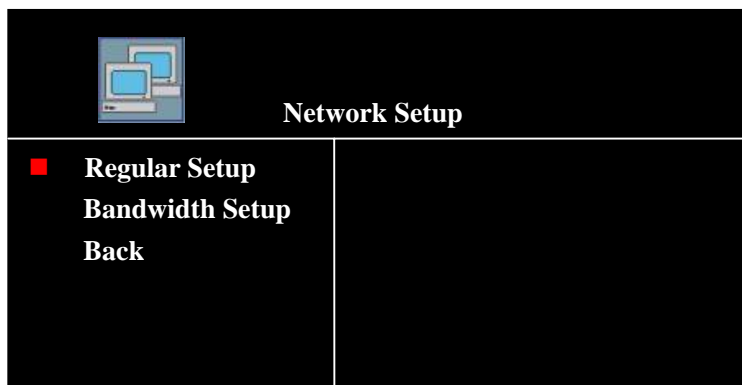

- Move the cursor to 『Regular Setup』 (the item with small red square is selected), press **【ENTER】** to enter the Setup interface:

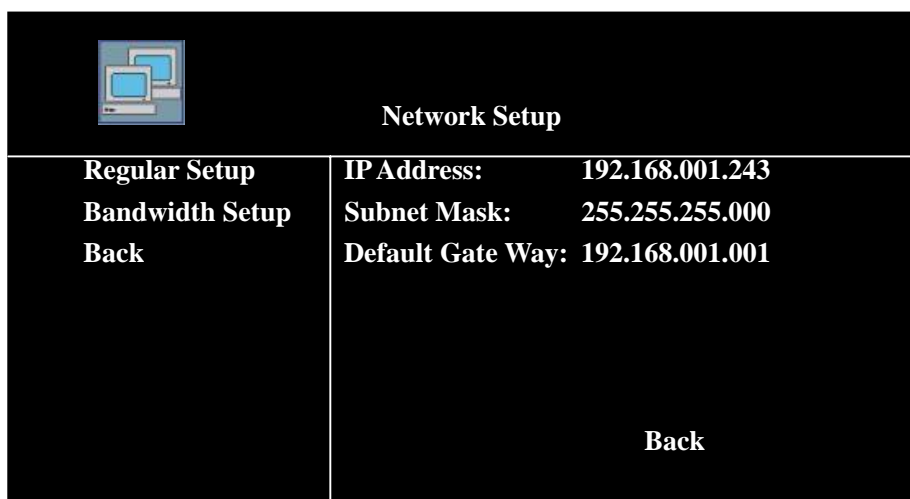

Remark: The view above is the interface of Regular Setup when the administrator uses the password 88888888 (eight 8) to log in, if administrator uses super password to log in, MAC Address will be added to the interface of Regular Setup, as follows:

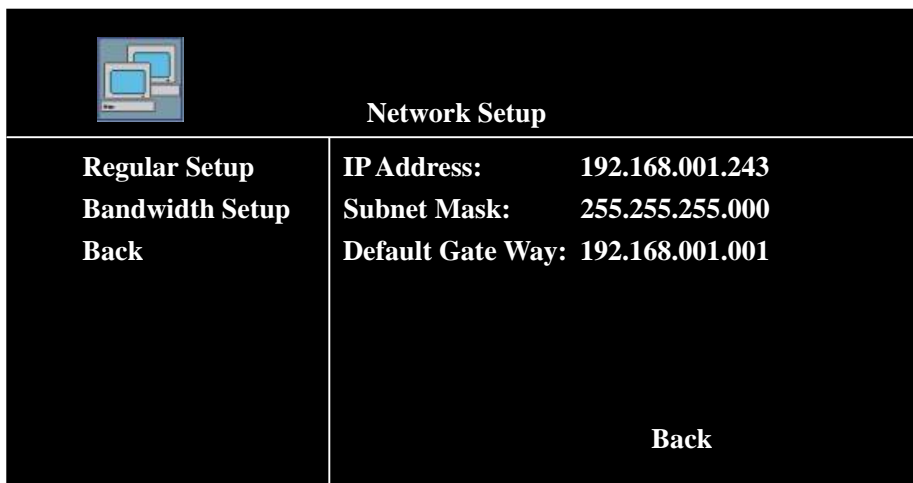

- ◆ **IP Address:** Move the cursor to the item, press **【ENTER】** or input numbers directly. According to the network the unit in, set the IP Address of the unit correctly.
- ◆ **Subnet Mask:** Move the cursor to the item, press **【ENTER】** or input numbers directly, according to the LAN the unit in, input the subnet mask correctly.
- ◆ **Default Gate Way:** According to the IP address setting.
- ◆ **MAC Address:** Move the cursor to the item, press **【ENTER】** or input numbers directly, set the MAC address correctly.

Remark: In the MAC address, the first byte is “000”, the bytes after it can be any numbers between 1 ~ 254.

- Move the red cursor to **『Bandwidth Setup』** , press **【ENTER】** to enter the interface:

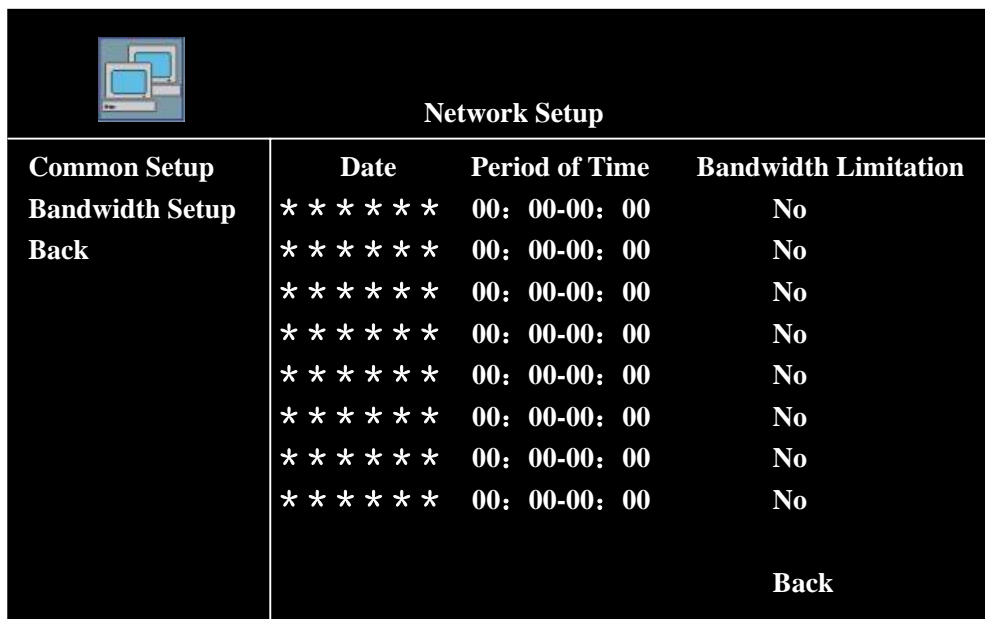

Date: 『Everyday/Monday to Sunday/*****』 eight choices for user, 『*****』 means no date, user can switch among the choices through **【ENTER】** or +/-key.

- ◆ **Period of Time:** Set the period of time of the bandwidth limitation.

Tip: Date can be multi-item set repeatedly, for satisfying requirement of multi-period recording in the same date

Remark: When you set the recording period, time in front of “——” must be earlier than the time behind “——”.E.g. Setting as follow is wrong: “13:00——11:30”.

Bandwidth Limitation: There are five choices, they are: Limitless, 384K, 512K, 1M, 2M.

3.2.8 PTZ Setup

Move the cursor to 『PTZ Setup』, press 【ENTER】 to enter the interface of PTZ port of 8 channels.



- **Channel:** It stands for 1-8, All total 17 choices of the channel number.
- **Protocol:** It stands for the communication protocol between the system and the decoder. Move the cursor to the item, press 【ENTER】, “+” or “-” key, you can select different protocols (Pe1co-P / Pelco-D / DSCP / Pelco03 ~ Pelco15), only the protocol selected matches the protocol of the decoder, you can operate the front end unit;
- **Bit Rate:** It stands for the communication speed between the system and the decoder. Move the cursor to the item, press 【ENTER】, “+” or “-”, key you can select different bit rate (1200/2400/4800/9600) , only the bit rate selected matches the bit rate of the decoder, you can operate the front end unit;
- **Address Code:** Move the cursor to the item, press 【ENTER】, “+” or “-”, key, you can select different PTZ number (01-63) , 01 is corresponding to the first address code of the decoder, namely address code “00”.
- **Test:** Select **Test**, enter single window screen, you can test PTZ of every channel.

Remark: Parameters of PTZ Protocol, Bit Rate, PTZ Number three items shall be the same as the parameters of PTZ (speed dome).

- **Operation of PTZ:** After correctly setting the parameters of PTZ, press 【F2】 on the remote control or 【PTZ】 on the panel in the single window screen surveillance (PTZ indicator is on), “channel X : PTZ Control” characters display on the top left corner of the screen, you can

operate the PTZ of the channel through remote control or panel at this time.

【▲】 , **【▼】** Keys: Len move upward, downward, display characters: PTZ Up, PTZ Down;

【▲】 , **【▼】** Keys: Len move leftward, rightward, display characters: PTZ Left, PTZ Right;

【ZOOM+】 , **【ZOOM-】** Keys: Adjust image zoom, show characters: ZOOM+, ZOOM-

【IRIS+】 , **【IRIS-】** Keys: Adjust image intensity, show characters: IRIS+, IRIS-;

【FOCUS+】 , **【FOCUS-】** Keys: Focus adjustment, show characters: FOCUS+, FOCUS-;

【AUTO】 Key: Auto control, show characters: AUTO;

【TRANSFER】 Key: PTZ transfer control, show characters: TRANSFER 00;

【PRESET】 Key: PTZ transfer control, show characters: PRESET 00;

【BRUSH/LIGHT】Key: Brush and light and other auxiliaries switch control; show characters: BRUSH;

Press **【F2】** or **【PTZ】** again, to escape from the PTZ operation, Return to single window surveillance status; Switch the surveillance image,

【F2】 Key: Operate PTZ of another channel.

Remark 1: System doesn't recording manually while operating the PTZ.

Remark 2: If system starts to record (timing or alarm start), and the image will switch to four windows surveillance screen while operating the PTZ, but it won't affect the PTZ operating.

Remark 3: If PTZ can not be operated regularly, please check the RS-485 link (refer to "Alarm Port Pins Definition") and parameters of PTZ Setup.

3.2.9 EXIT

Move the cursor to the item, press **【ENTER】** , namely save the Setup and escape the setting menu, Return to the surveillance image.

Tip: All interface of System setups, only when [Return] is selected, you'd better select this item, you can save the Setup in the page precisely. If you don't select the item, press 【EXIT】 on the remote control or panel directly, the system will Return to the surveillance image directly, and you can't save the Setup.

4 Checking Operations

After logging in, press **【CHECK】** key to enter the query menu, press direction keys to select the item needed, press **【ENTER】** key to enter the item.

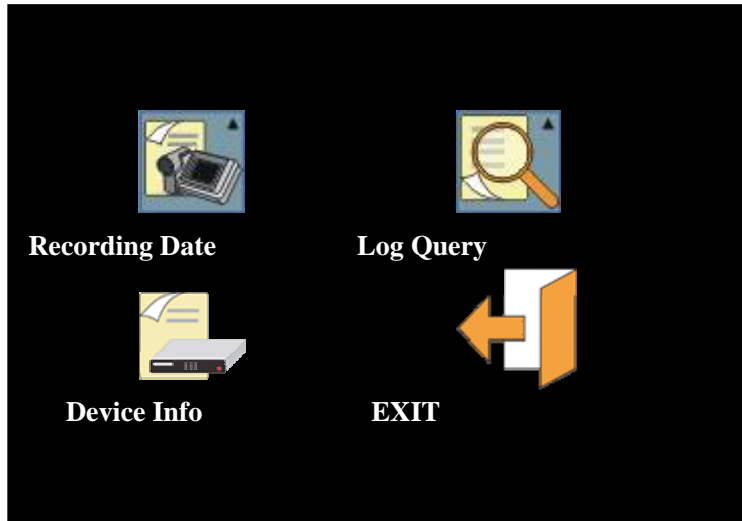

4.1. Recording Data

Move the cursor to 『Recording Data』, press **【ENTER】** key to enter the submenu. Press **【ENTER】**, “+”, “-” keys to select the recording Channel or Date and Time to check the item at this time (as the following view).



Move the cursor to “**Start**” , press **【ENTER】** key to the state of hard disk searching, after searching the system will auto enter the submenu (as the following view).

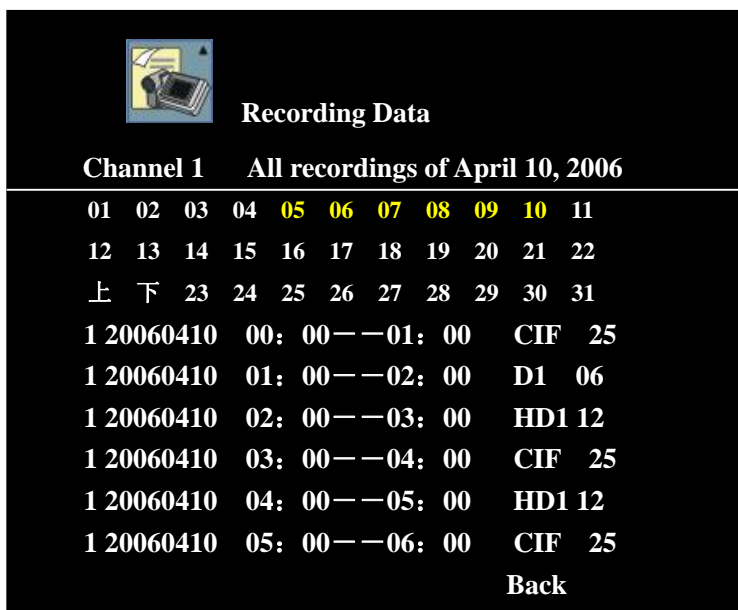
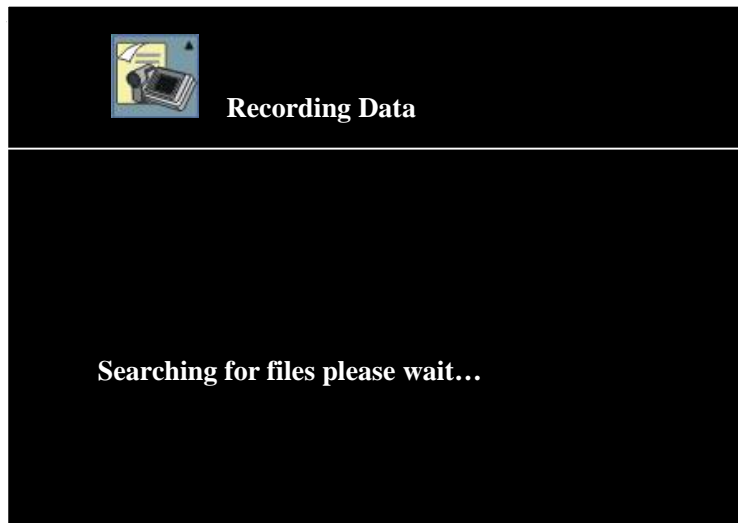

The recording data of the channel and date selected display in the submenu, you can move the cursor upward or downward to select different date, press “+”, “-” key to move the cursor upward, downward to page up and page down and select the recording period of time, press **【ENTER】** key to check the data, data of which date is printed yellow is the intraday recording data.

If there is no data of the date selected, “**No Data That Day**” will display on the screen. Recording data of some dates can’t display all in a page, move the cursor to “Up”/ “Down”, press **【ENTER】** or “+/-” to page, you can check the data page by page.

Recording data section of the view above, “1” stands for the video data is recorded in hard disk 1, “20060410” displays the name of the file (named by Year, Month and Day). “01:00-02:00” displays the start and stop time, “D1” displays the image quality, and “06” is frame rate.

Name: Address name of the channel;

- **Period:** Every recording time (Packing Time) of data of all recording periods of time, is max 60 minutes.
- **Resolution:** D1, HD1, CIF three levels, stand for which resolution the video data is.
- **Frame Rate:** When the system is set to PAL, the frame rate is divided into five levels i.e. “25, 12, 06, 03 and 01”. When the system is set to NTSC, the frame rate is divided into five levels i.e. “30, 15, 08, 04 and 02”. The levels stand for use which frame rate to record the image data.

Move the cursor to the item you need to check, press **【ENTER】** key or PLAY key to enter the playback image.

Remark: 1. Press 1, 2, 3 and 4 keys to switch the recording data among all channels of the group while playback, such as:

Press number 2 while the recording data 01: 00——02: 00 is playing back, the system will give a hint:

“Switching to the channel 02, please wait...”, then recording data of the same time of channel 02 will appear.

2. If Clock is set to on in the Channel parameters before, the clock while recording will display on the playback image;
3. If Clock isn't set in the Channel parameters, the clock while recording can display if **【ENTER】** key is pressed. At this time, press **【F1】** key to select time quantum to playback; press **【SLOW】** key to playback in low speed of 1/2×, 1/4×, 1/8×; press **【FF】** key to fast forward playback in forward 1 and forward 2 speed; press **【REW】** key to reverse playback; and press **【STILL/F.ADV】** key to playback frame by frame. Press **【EXIT】** key to escape from the playback image, Return to the previous menu.
4. After recording of this period of time has been played, recording data of next period will be auto played.

4.2. Log Search

Move the cursor to 『Log Search』 item, press **【ENTER】** key to enter the submenu. Press **【ENTER】**, “+” or “-” key at this time to select the type of log need to check (**All Log, Alarm Log, Motion Log, Access Log**) (as the following view).



After selecting, move the cursor to “**Start**”, press **【ENTER】** key to enter the submenu, such as select the **Access Log**, the interface is as following:



The log data of the type of log is display in the submenu, the time at which the log happened was recorded in every log.

Remark: 1. when select “All Logs” to check, all records of three types of log will display.

- 2. Access Log means what are accessed, including a. Parameters Change, b. Restart, c. Manual Recording, f. Format Hard Disk, g. Reset Setup.**
- 3. Alarm Log means what matters cause the alarm, such as: Password Error (input three times of wrong password repeat); Video Missed; Hard Disk Failure.**
- 4. Motion Log record the matters of motion detect, including the time, channel, matter and motion detect mark while motion detecting.**
- 5. When no log of the item selected, blank page will display on the screen. Recording data of some dates can't be displayed all in a page, press **【ENTER】** key or “+/-” key to turn the page, you can check the data page by page.**

4.3. Device Info

Move the cursor to **【Device Info】** , press **【ENTER】** key to check **Channel Status, Hard Disk Information and Soft Version.**

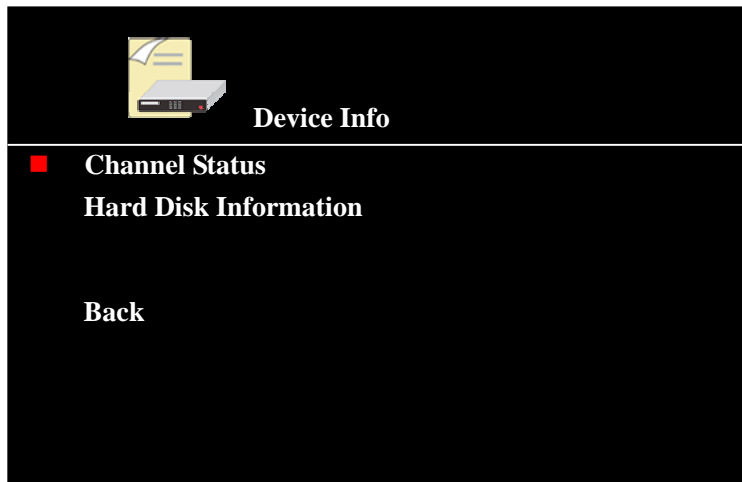

- ◆ If you select **Channel Status** (press Upward, Downward key, red square mark in front of the item means the item is selected), then press **【ENTER】** key to enter the interface, recording Status, Image Quality, Resolution, Frame Rate of 8 channels will display in this interface. Interface is as the following view:

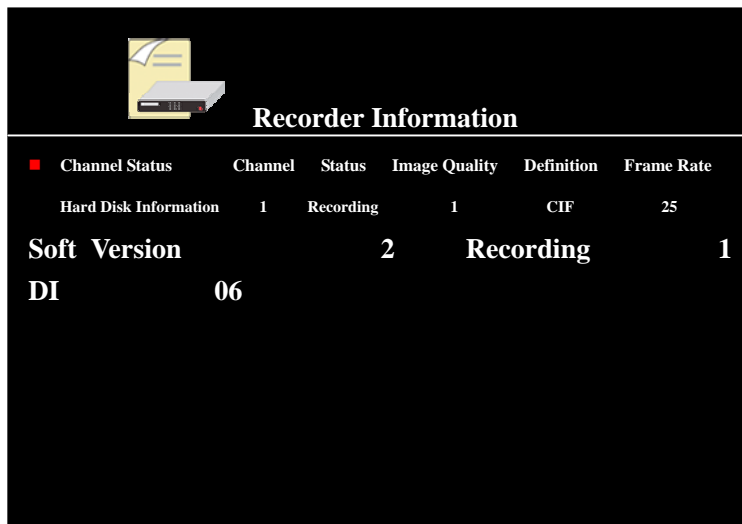

- ◆ If **Hard Disk Information** is selected (press Upward, Downward key, red square mark in front of the item means the item is selected), then press **【ENTER】**key to enter the interface, status including Capacity and Remained Capacity of 8 hard disks will display in this interface. Interface is as the following view:



Device Info

Channel Status	Hard Disk	Status	Capacity	Remained Capacity
■ Hard Disk Information	1	Recording	301G	008.496MB
Soft Version	2	Dormancy	298G	001.497MB
Back	3	Dormancy	301G	001.514MB
	4	Dormancy	301G	001.445MB
	5	Dormancy	161G	001.892MB
	6	Dormancy	298G	001.497MB
	7	Dormancy	301G	001.514MB

If you select **Soft Version** and press **【ENTER】** key to enter the interface, local **Soft Version** will display.



Recorder Information

Channel Status	Soft Version: 6516E-A-01.000
Hard Disk Information	
■ Soft Version	
Back	

Remark: The view above is the interface of Device Info when the administrator uses the password 88888888 to log in, if administrator uses super password to log in, MAC Address will be added to the interface of Device Info.

4.4. EXIT

Move the cursor to this item, press **【ENTER】** key to confirm, Return to the surveillance image.

5 Other Operations

5.1. CF Card Operations

5.1.1 CF Card Upgrade

Format CF card to FAT32 at first, and then copy the upgraded software program from PC to CF card then. **Disconnect the power** of the digital video recorder, insert the CF card with Upgrade program to the CF card slot of the video recorder, pin **【ENTER】key** or **【ON/OFF】 key without release**, connect the power of the recorder, after 10 seconds, the Channel and Power indicators are blinking, that means the recorder is being upgraded, release your hand; Wait about one or two minutes, Upgrade finishes, and the Channel and Power indicators stop blinking; the recorder is in the state of standby, Upgrade succeed. Take out the CF card after disconnecting the power of the recorder, restart the recorder.

5.1.2 Other Operations of CF Card

If you want to operate the CF card, please disconnect the power of the recorder, insert CF card to the CF slot, restart the recorder.

After logging in, in the status of **stopping recording**, a. Press **【SET】 key** on the panel or remote control to enter the interface of **Setup**,

- b. **Select External Storage** in **General Setups**,
- c. Move the cursor to item of **External Memory Equipment**, press **【ENTER】key** to enter and select **“CF Card”**.
- d. Move cursor to **“CF Card”**, press **【ENTER】key** to enter submenu of **“CF Card”**:

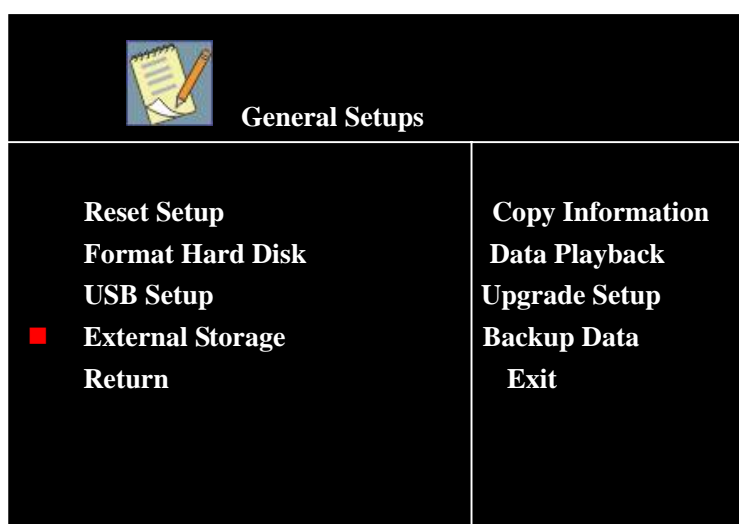

You can do a series of other operations of CF card; including **Copy Information**, **Playback Data**, **Upgrade Setup** and **backup Data** (see the following sections).

5.1.3 CF Card backup Data

If you need to backup the recording data of the hard disk to the CF card, **move the cursor to “Return up Data”, press 【ENTER】 key to copy the recording data, details are as follows:**

① Part Recording Data Copy:

Move the cursor to **“Data backup”** (reverse characters mean the item is selected), press **【ENTER】 key** to enter the **Recording Data** of the copy which can be provided:



And then **search** the video data needed to backup (including Channel, Date and Time can be selected), select a channel (select **01** as the view above) to enter the interface in which all recording data of the channel is recorded:

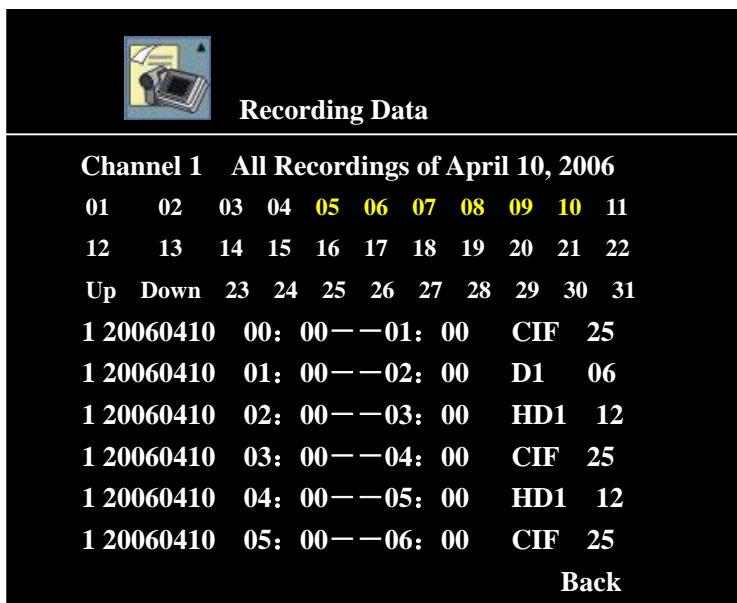

After selecting the recording of some date, period of time, press **【ENTER】** key enter playback the recording data. If you want to playback, press **【CF】** key on the remote control or panel immediately, “Copying...” will display, it means it is copying; if copying finishes, press **【CF】** key on the remote control or panel to stop copy, “Copying...” will disappear. So the video data needed to backup to the CF card completely.

② **Full Recording Data Copy:**

Move the cursor to **Data backup**, press **【ENTER】** key to enter, **search** the video data block (including Channel, Date and Time can be selected) of the content needed to return, after selecting the recording data of a channel, a date, a period of time (move the cursor to period of time needed to be copied), press **【CF】** key on the remote control or panel, “Please Press Again to Confirm Copy” will display on the bottom-left screen (as the following view):

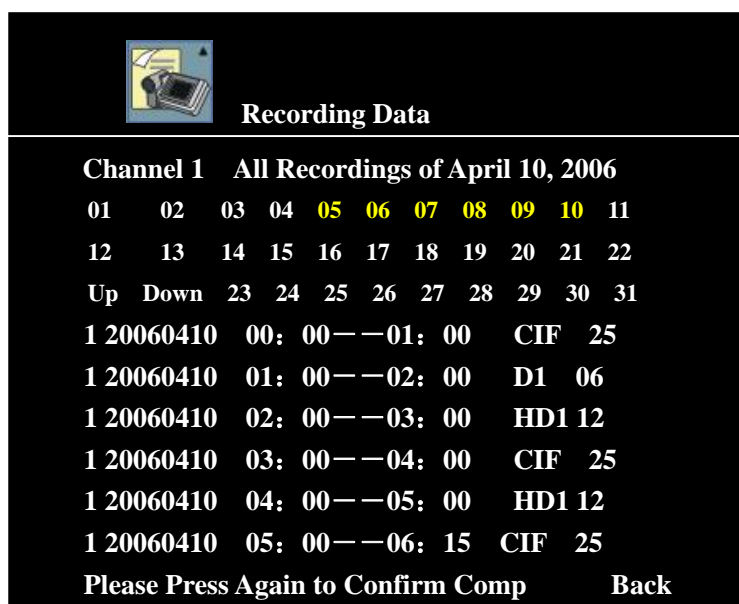

Press **【CF】** key again, if the capacity of CF card is smaller than the capacity of the period of time, “Ineffective” will display; If the capacity of CF card is not smaller than the capacity of the period of time, “Copied: Completed Percentage” will display. When it finishes, it will display: Copy Complete.

Remark: Please ensure the capacity of CF card is larger than the capacity of the period of time before Full Recording Data Copy, and then operate it.

5.1.4 CF Card Data Playback

Move the cursor to “**Data Playback**” (reverse characters mean the item is selected), press

【ENTER】 key to enter the interface.

If there is no content in the CF card, No Record will display in the interface of CF Card Data Playback;

If there is content in the CF card, the content recorded will display in the interface of CF Card Data Playback (as the following view).



CF Card Contents Playback: Move the cursor the period of time needed to playback, press 【ENTER】 key, start to playback; press 【EXIT】 key to stop playback.

5.1.5 CF Card Copy Information and Upgrade Setup

If you want to backup the parameters Setup of the system to the CF card, move the cursor to “Copy Information”, press 【ENTER】 to copy the information. This function can copy all Setup and logs of the recorder copy to “CF card”.

If you want to set multi recorder s in the same status, you can set one recorder first. After the recorder is disconnected to the power, insert CF card to the CF slot, then connect the recorder to the power, after the system starts, enter **CF Card Operations** in **External Memory Equipment**, move the cursor to “Copy Information”, press 【ENTER】 key, you can copy the Setup of this recorder to CF card, “Copying” will display on the screen; After copying, “Succeed” will display at the bottom of interface of CF Card Operations. If copy is fail, “Failure” will display at the bottom of interface of CF Card Operations.

If you want to set the status of a recorder the same as another, you can use **Copy Information**, copy Setup of another recorder to the CF card, then insert the CF card to the CF card slot of a recorder while it is disconnected to the power; after the system starts, press 【CF】 to enter the menu of CF Card Operations ,move the cursor to “Upgrade Setup”, press 【ENTER】 key, “Upgrade Setup...” will display on the screen, the Setup of the recorder auto reset the same as the Setup of that recorder at this time. After reset the Setup, “Complete” will display at the bottom of interface of CF Card Operations, then “Restarting...” will display, the recorder auto restart at this time.

5.2. CD Operations

If you want to operate CD, please disconnect the power to the recorder , and connect the CD writer as slave to the IDE interface, and restart the recorder .

After logging in the system:

- a. press the **【SET】** key on panel or remote control to enter **Setup** interface,
- b. Select **External Memory Equipment** in **General Setups**,
- c. Move the cursor to item of **External Memory Equipment**, press **【ENTER】** key to enter and select “**CD Operations**”.

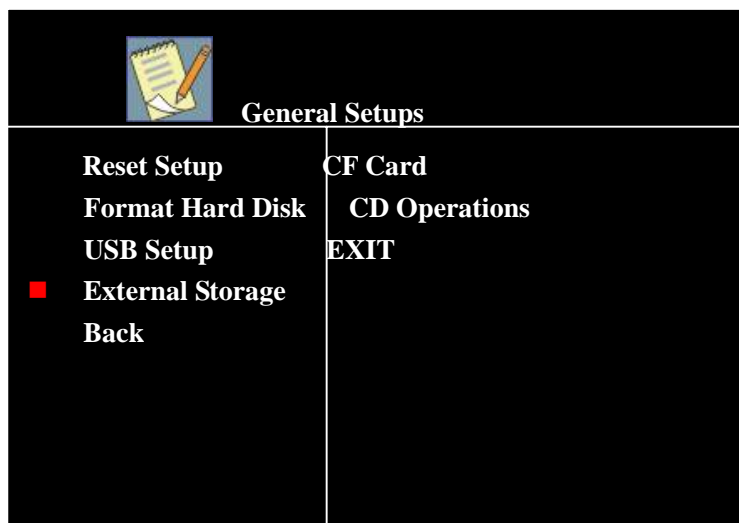

Move the cursor to “**CD Operations**” (reverse characters mean the item is selected), press **【ENTER】** key to enter the submenu of “**CD Operations**”:

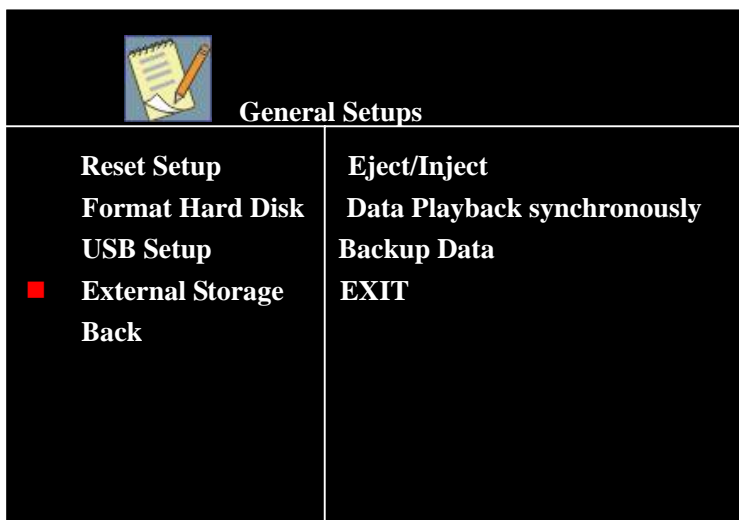

5.2.1 Eject/Inject

Move the cursor to “Eject/Inject” (reverse characters mean the item is selected), press **【ENTER】** key to eject or inject (take out or put in CD)

5.2.2 CD Back up Data

If you need to backup the recording data of the hard disk to CD, move the cursor to “backup Data”, press **【ENTER】** key to enter the interface as follow:

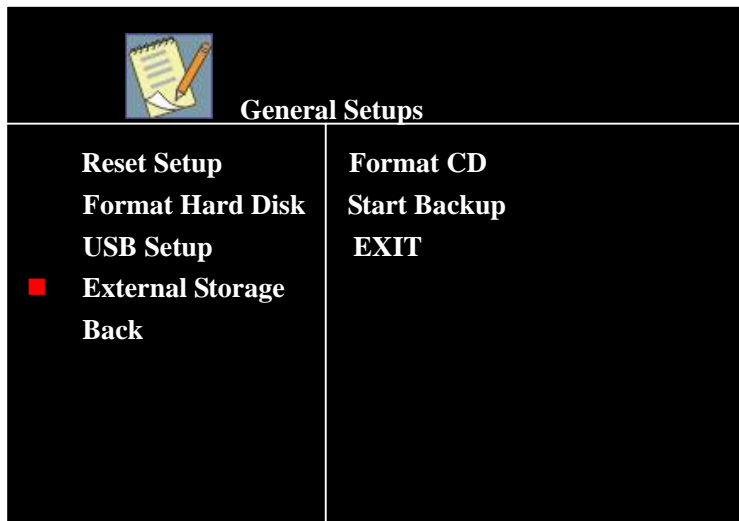

If it is a new CD, it must be formatted first, and then you can start to backup recording data, otherwise it isn't necessary to format CD, and details are as follows:

① Part Recording Data Copy:

Move the cursor to “**Start Backup**” (reverse characters mean the item is selected), press **【ENTER】** key to enter the **Recording Data** of the copy which can be provided:



And then **search** the video data needed to backup (including Channel, Date and Time can be selected), select a channel (select **01** as the view above) to enter the interface in which all recording data of the channel is recorded:

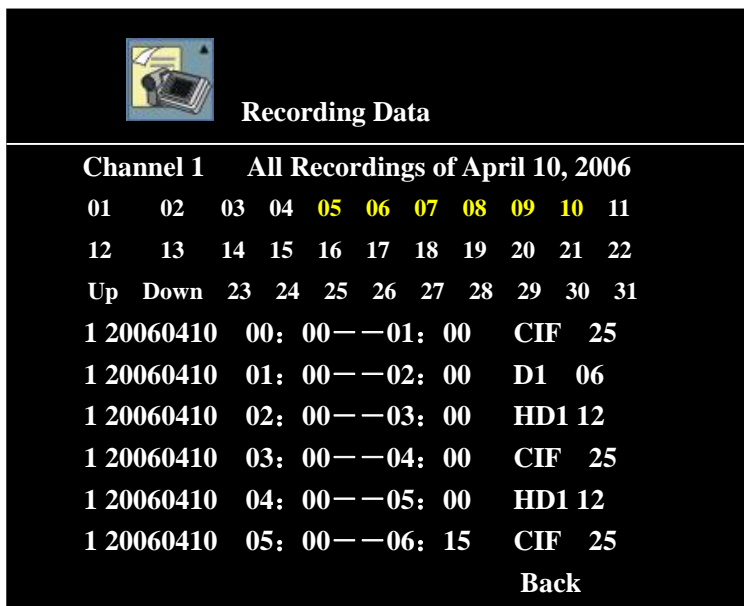

After selecting the recording of some date, period of time, press **【ENTER】** key enter playback the recording data. If you want to playback, press **【CF】** on the remote control or panel immediately, “Copying...” will display on the top right corner of the screen, it means it is copying; if copying finishes, press **【CF】** on the remote control or panel to stop copy, “Copying...” will disappear. So the video data needed backup to the CD completely.

② **Full Recording Data Copy:**

Move the cursor to **Start Backup**, press **【ENTER】** key to enter, **search** the video data block (including Channel, Date and Time can be selected) of the content needed to backup, after selecting the recording data of a channel, a date, a period of time (move the cursor to period of time needed to be copied), press **【CF】** on the remote control or panel, “Copied: 0%” will display on the bottom-left screen after two or three minutes (as the following view), data copy starts:

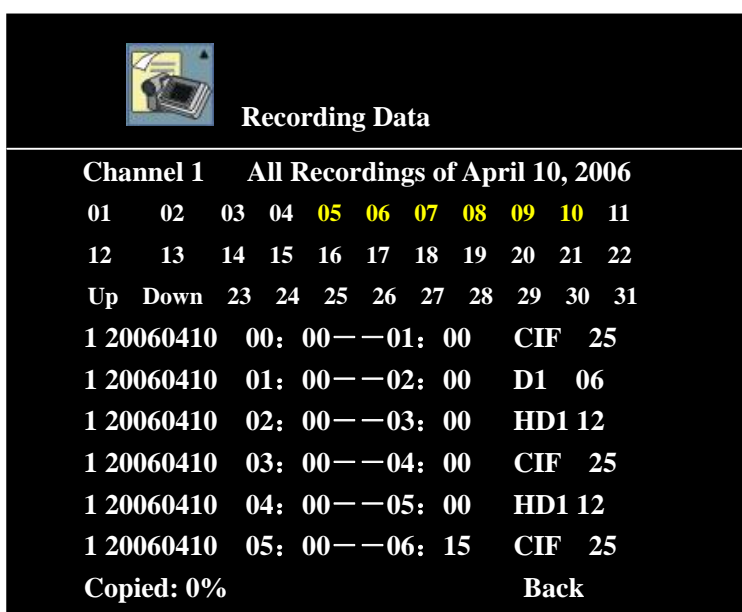

Till it is copied 100%, move the cursor to copy the others, or press Return to exit .If the capacity is smaller than the capacity of the period of time, “Ineffective” will display;

Remark: Please ensure the capacity of CD is larger than the capacity of the period of time before Full Recording Data Copy, and then operate it.

5.2.3 CD Data Playback

Move the cursor to “Data Playback” (reverse characters mean the item is selected), press **【ENTER】** key to enter the interface.

If there is no content in CD, No Record will display in the interface of CD Data Playback;

If there is content in CD, the content recorded will display in the interface of CD Data Playback (as the following view).

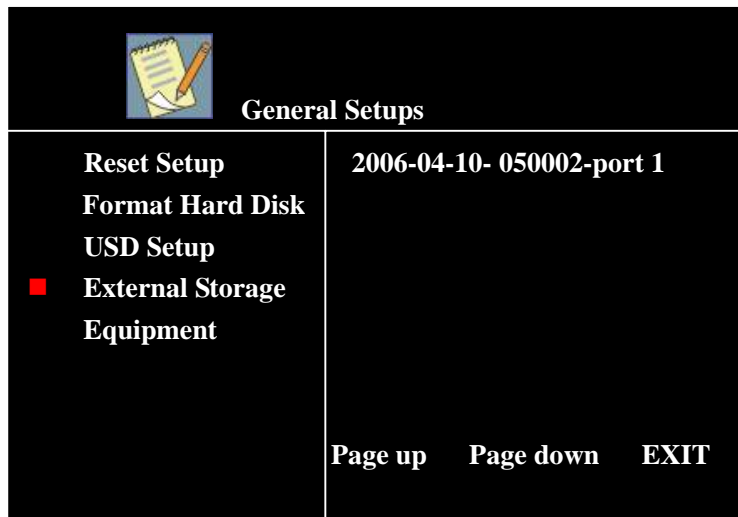

CD Contents Playback: Move the cursor the period of time needed to playback, press **【ENTER】** key, start to playback; press **【EXIT】** key to stop playback.

5.3. Recording and Playing

5.3.1 Recording

5.3.1.1 Manual Recording

Press **【REC】** key to start recording in 1-8 channels while 8 windows screen;

Press **【STOPREC】** key to stop manual recording.

5.3.1.2 Timer Recording

Referred to the corresponding contents of 『Recording Parameters Setup』 and 『Timer Record setups』 .

5.3.1.3 Alarm Recording

Referred to the corresponding contents of 『Recording Parameters Setup』, 『Timer Record setups』 and 『Alarm Record setups』.

Remark: While it is standby, there is 15~20 seconds delay from receiving the alarm signal to starting recording, because the hard disk need a set time to start working when it start alarm recording. If you want to avoid this problem, set the 8th item in 『Timer Recording Time Setup』 menu of channel 1 to “Rush Period” and set the period of time; so the recorder won't be auto standby in that period of time!

5.3.1.4 Motion Recording

Referred to the corresponding contents of 『Recording Parameters Setup』 and 『Motion Record setups』.

5.3.2 Playing

- Enable you to select Play All, Timer Recordings, Alarm Recordings, and Motion Recordings to play the video data.

Referred to the correspond contents of **Checking Menu**.

- Play the latest recording data

Press **【PLAY】 key** on the panel or remote control to play the video data which is recorded by this channel (play from the start of this period of time).

5.3.3 Time Selected Playing

Press **【F1】 key** while playing Return video data of one period, Time Selected menu will display on the screen.

Input time (must be double-digit), it will start to play from the time input of the current video period that is playing Return.

5.3.4 Stop Playing

Press **【STOP】 key** on the panel or **【EXIT】 key** on the remote control to stop playing the current video data, and Return to the upper interface.

5.3.5 Slow Playing

Press **【SLOW】 key** to enter the state of slow playing while normal playing.

Press the key repeat, it will play in four status of “1/2×”, “1/4×”, “1/8×” and “Play”.

Press **【PLAY】 key** to Return to normal playing status while slow playing

5.3.6 Still and Frame Advance

Press **【STILL/F.ADV】 key** to make the image still, playing is suspended.

Press **【STILL/F.ADV】 key** once, one frame advances while the image is still.

Press **【PLAY】 key** to Return to normal playing status while the image is still or play frame by frame.

5.3.7 Fast Forward

Press **【FF】 key** to enter the state of fast forward playing while normal playing.

Press the key repeat; it will play in “Forward 1”, “Forward 2”, and “Play” three status.

Press **【PLAY】 key** to Return to normal playing status while fast forward playing

5.3.8 Fast Reverse

Press **【REW】 key** to enter the state of fast reverse playing while normal playing.

Press the key repeat; it will play in “Reverse 1”, “Reverse 2”, “Play” three status.

Press **【PLAY】 key** to Return to normal playing status while fast reverse playing

5.4. Adjustments of Analog Quantities and Motion Sensitivity

5.4.1 Adjustments of Analog Quantities

You can adjust the analog quantities of the channel while the recorder stops **recording** and in the state of **single window surveillance screen**.

■ Adjustment of Brightness:

Press **【ADJ】 key**, adjustable item of brightness will display on the screen

Press **【-】** or **【+】 key** to reduce or increase the brightness.

■ Adjustment of Definition:

When the adjustable item of brightness displays on the screen, press **【ADJ】 key**, adjustable item of definition will display on the screen.

Press **【-】** or **【+】 key** to reduce or increase the definition.

■ Adjustment of Saturation:

When the adjustable item of definition displays on the screen, press **【ADJ】 key**, adjustable item of saturation will display on the screen.

Press **【-】** or **【+】 key** to reduce or increase the saturation.

■ **Adjustment of Color:**

When the adjustable item of saturation displays on the screen, press **【ADJ】**, adjustable item of color will display on the screen.

Press **【-】** or **【+】** key to reduce or increase the color.

5.4.2 Adjustment of Motion Sensitivity

While the recorder **stops recording** and in the state of **single window surveillance screen**, press **【ADJ】** key when the adjustable item of color displays, the adjustable item of motion sensitivity will display on the screen

Press **【-】** or **【+】** key to increase or reduce the sensitivity. The smaller the value is, the higher sensitivity will be.

If no operation in some time (about 5 seconds) while adjusting the analog quantities, the system will auto escape from the status of adjustment of analog quantities.



6508



6508