

**16 channels Embedded Digital Video Recorder**

**User's Instruction Manual**



# TABLE OF CONTECNTS

Section	Page
<b>Preface: Installation Guideline</b> .....	<b>4</b>
1 Installation Condition.....	4
2 Other notice.....	4
3 Introduction of HDD Installation.....	4
<b>Unit 1 Product overview</b> .....	<b>5</b>
1.1 Product overview.....	5
1.2.Product Functions/ Features.....	5
<b>Unit 2 System overview</b> .....	<b>7</b>
<b>1 System overview</b> .....	<b>7</b>
1.1 Panel and Keys.....	7
1.1.1 Indicators.....	7
1.1.2 Operation Keys.....	7
1.1.3 Ports .....	8
1.2 Rear Panel and Ports.....	9
1.3 Alarm Ports Output View.....	9
1.3.1 Alarm Port Pins Definition.....	9
1.3.2 Alarm wiring diagram.....	10
1.4 Remote Control .....	12
1.4.1Number Keys.....	12
1.4.2 Menu Operation Keys.....	12
1.4.3 PTZ Control Keys.....	13
1.4.4 Player Keys.....	13
1.4.5 Other Keys.....	13
1.5 Technical Specification data.....	14
<b>2 System Operations</b> .....	<b>16</b>
2 .1System Open/ shutdown.....	16
2.1.1 System Open.....	16
2.1.2 System Login.....	16
2.1.3 System Shut Down .....	18
2.2 System Function Settings.....	18
2.2.1 System Setup .....	19
2.2.2 Record Setup.....	21
2.2.3 Channel Setup .....	22
2.2.4General Setup .....	24
2.2.5 Alarm Setup .....	25
2.2..6 Work Task.....	25
2.2.7 Network Setup.....	29
2.2.8 PTZ Setup.....	30
2.2.9 Exit.....	32
<b>3 Checking Operations</b> .....	<b>32</b>

---

3.1 Recording Data.....	32
3.2 Log Search.....	34
3.3 Device Info.....	35
3.4.Exit .....	37
<b>4 Other Operation .....</b>	<b>37</b>
4.1. CF Card Operation.....	37
4.1.1 Update by CF card.....	37
4.1.2 Other Operations of CF Card.....	38
4.2 CD Operation.....	38
4.3 Analog Quantity Adjustment.....	39
4.4 Recording and Playing.....	40
4.4.1 Recording.....	40
4.4.2 Playing.....	40
4.4.3 Stop Playing.....	40
4.4.3 Play Slow.....	40
4.4.4 Pause and step.....	41
4.4.5 FWD REW.....	41

## Preface: Installation Guideline

**Warning: Be sure power off before DVR connecting with the other devices**

### 1 Installation Condition

In order to ensure the safety with the DVR product and maximize product performance, keep DVR product in normal condition, please notice the following remark while/ before install the product:

- a) Only use with AV220V/AC110V (please notice the voltage switch on the back of transformer) voltage supply, please check with the power supply with correct voltage before installation. DO NOT USE WITH ANY DIFFERENCE SOURCE (DO NOT PLUG INTO AC380V HIGH VOLTAGE SUPPLY!)
- b) The HDD brand we recommend is SAMSUNG CE series, or SEAGATE SV series.  
OR, we recommend that you'd better use SAMSUNG CE series. Or SEAGATE SV series HDD.DVD+RW CD, and KINGSTONE CF card.
- c) Away from humidly place or exposure with rain
- d) DVR should be install with horizontal position
- e) DVR should be avoid to locate in shocking place
- f) Avoid to expose DVR with direct sunshine, and away from high temperature;
- g) For the heat transfer and ventilation purpose, require at least 15cm space distance between DVR and other object (such as wall) while install the device
- h) Correct grounding for the DVR device while operating
- i) Check with the connection with other equipment while DVR operating

### 2 Other notice

- j) Do not operate the device with wet hands
- k) Away from any web place, fire hazard occur by short circuit damage by any liquid drop to device
- l) Do not place anything on the top of device
- m) Use soft cleaner to clean the device, no chemical cleaner use here
- n) Live voltage does exist while the device is being connected with power supply, even device off.
- o) Please disconnect the power supply while long time not using
- p) If the DVR does not operate correctly, do not disassemble it without authorization. Contact your local agency for after sales service. The warranty will become invalid if it is disassembled without authorization.

### 3 Introduction of HDD Installation

Take down screw on the upper cover and then open it to take down HDD mounting bar. Bring out screw in accessory box and fix HDD on the mounting bar. Install or increase

HDD, Do must do it as the following:

IDE1 connect the 1<sup>st</sup> group HDD: the 1<sup>st</sup> HDD should be set as the main disk and the 2<sup>nd</sup> as the subsidiary disk;

IDE2 connect the 2<sup>nd</sup> group HDD: the 3<sup>rd</sup> HDD should be set as the main disk and the 4<sup>th</sup> as the subsidiary disk;

IDE3 connect the 3<sup>rd</sup> group HDD: the 5<sup>th</sup> HDD should be set as the main disk and the 6<sup>th</sup> as the subsidiary disk;

IDE4 connect the 4<sup>th</sup> group HDD: the 7<sup>th</sup> HDD should be set as the main disk and the 8<sup>th</sup> as the subsidiary disk;

**Remark:** Log recording store in the 1<sup>st</sup> HDD, if not set as main disk ,log recording will not exist.

**Remark:** This device had been certified with the international safety standard.

## Unit 1 Product overview

### 1.1 Product overview

This recorder is a kind of digital surveillance product designed for the security area. It adapts embedded processor and operation system. What else, many kinds of the latest technologies in IT area are benefit to our product: MPEG-4, video/ audio compression, a large HDD recording, and TCP/IP network technology. It can be used in safety and protection of bank, telecommunication, electric power, justice, traffic, district, factory, storehouse, resource, water conservancy facilities and other fields or parts.

### 1.2. Product Functions/ Features

- High speed embedded CPU and real time embedded control operation system are adapted with the product, it provide operation stability, no hang-up error, more reliability and easy for maintain
- Operation with front panel and remote control, menu language also available for English/ Chinese (Simplified)/ Chinese (Traditional), security with double password lock. System management require for authority code in order to provide safety system
- Using with hardware MPEG-4 encode to provide better streaming quality, it also support with D1, 1/2D1, CIF resolution, as well as adjustable frame rate and provide space efficiency with compact video size
- Storage used with FAT32 format, suitable for 1-2 IDE hard drive connections, there are 3 types of store method can use in here: individual, compound and mixed
- Provide multi-channels operation, such as:
  - ◆ 16 channels video input capture

- ◆ 2 channels video output
- ◆ 1 channel VGA output
- ◆ 16 channels audio input [e1]
- ◆ 2 channels audio (right/left) output
- ◆ 2 channel spot output[e2]
- 4 channels alarm input with programmable setting
- 16 channels alarm input with programmable setting
- With kinds of surveillance display screen (1/4/8/16 windows per screen) and each individual display screen with audio surveillance function
- Time setting to activate recording system with auto switching, system re-activate after power shut down. Alert system for any video signal loss or disturb
- Available for manual, time setting, alert playing, this will make the unit more effectively and hard space efficiency. Also for the motion detect function available with setting for 16X12(192) detect region area, with adjustable sensitivity detect level
- Pre-setting record function and extend alert function, in order to ensure alert information 100% capture with user requirement
- Available for x2 and x4 fast forward/ backward function and slow motion rate at x1/2, x1/4 and x1/8 as well as pause and frame-by-frame function
- PAL/ NTSC system available
- Individual setting for each capture channel for brightness, contrast, color, motion detect setting
- Complete daily report for alarm record and operation record, good for monitor record and analysis
- Support with TCP/IP, UDP/ IP internet protocol
- Using client software for internet explorer
- RS-485 connection for the platform decoder, available for difference frequency setting and decoder parameter, as well as extendable function for the decode function
- VGA output provide better video quality and progressive scan option as well
- Support Compact Flash card storage and IBM Micro drive disk
- Support with IDE hardware image.
- Use USB 2.0 port

## Unit 2 System Operation Manual

### 1 System overview

#### 1.1 Panel and Keys

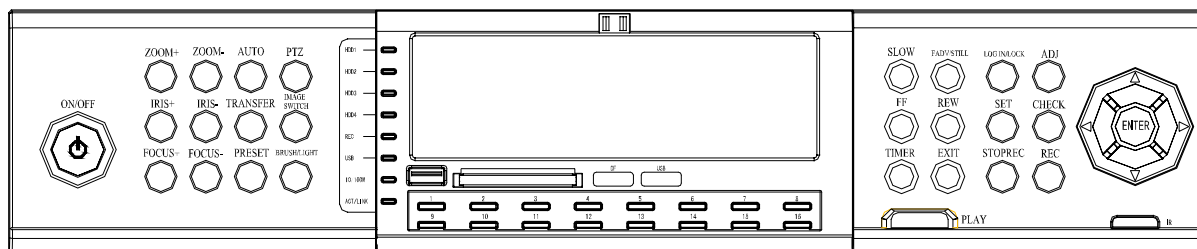

#### 1.1.1 Indicators

- LED 1-16 Indicators:  
Recording indicators are corresponding to 16 channels, the indicator will be off while the channel isn't recording; the indicator will be on while recording; and the indicator will be blinking while alarm;
- HDD 1-4: Hard Disk Indicators  
Blinking while hard disk is working, off in other status;
- LINK/ACT:  
ON--Ethernet connects correctly, BLINKING--sending or receiving data;
- 10M/100M:  
Network speed indicator ON-100M, OFF-10M;
- Recording Indicator:  
ON--recording, OFF--not recording;
- PTZ Indicator:  
Indicator below PTZ Control Key is on while PTZ Control Key is activated, off while Number Keys are activated;
- Standby Indicator:  
The indicator is red while the equipment is standby, and off while working;
- USB: On while USB is working, off while not working;

#### 1.1.2 Operation Keys

##### 1.1.2.1 PTZ and Number Control Keys

- 【PTZ】 Key: Changing PTZ control key, press it to enter PTZ operation status, press again to exit the PTZ operation status;
- 【ZOOM+】 , 【ZOOM-】 Keys: Zoom in and zoom out;
- 【IRIS+】 , 【IRIS-】 Keys: Adjust image brightness;
- 【FOCUS+】 , 【FOCUS-】 Keys: Adjust image definition;
- 【AUTO】 Key: Auto control;
- 【TRANSFER】 Key: PTZ transfer control;
- 【PRESET】 Key: PTZ preset control;
- 【BRUSH/LIGHT】 Key: Brush and light control;

- **【0-9】** Keys: Number keys, for number input or video channel switch, enable you to change the screen to single window screen output with number keys without menu, such as pressing 01 keys (press 1 when 0 displays) means changing to the 1st channel window screen, pressing 12 keys (press 2 when 1 displays) means changing to the 12th channel window screen

**REMARK: Press double numbers to change.**

### 1.1.2.2 Playing Control Keys

- **【SLOW】** Key: Slow play the image, 1/2x, 1/4x, 1/8x speed;
- **【Pause】** Key: Press to pause, press the key repeatedly, one press one frame;
- **【REW】** Key: Reverse to playback, Reverse 1/2 speed;
- **【FF】** Key: Fast forward to playback, Forward 1/2 speed;
- **【TIMER】** Key: For selecting time quantum while playing recording;
- **【EXIT】** Key: Escape from the operating menu to the surveillance image directly.
- **【LOG IN/LOCK】** Key: Get operating authority, namely to enter password and lock operation;
- **【ADJ】** Key: For adjustment of brightness, saturation and others while surveillance;
- **【SET】** Key: For setting parameters of the system;
- **【CHECK】** Key: For checking the data in hard disk;
- **【REC】** Key: 16ch manual recording simultaneously while 16 windows screen, 4ch manual recording simultaneously while 4 windows screen, 1ch manual recording while 1 window screen;
- **【STOP REC】** Key: Stop manual recording;
- **【PLAY】** Key: Used for scan the recordings or playback.

### 1.1.2.3 Other Keys:

- **【ENTER】** Key: System time will display when ENTER Key or PLAY Key is selected;
- **▲**: Upward Direction Key and Pause Key;
- **▼**: Downward Direction Key and SLOW Key;
- **◀**: Leftward Direction Key and REW Key;  
Rightward Direction Key and FF Key;
- **【ON/OFF】** Key: For system on or off (standby or on);

### 1.1.3 Ports

- **CF CARD**: CF card slot, enable to upgrade program and Backup data.
- **IR**: Remote signal receiving window
- **USB**: USB port connect to PC, download and Backup data

### 1.2. Rear Panel and Ports

- Power Fan
- AC220V Power Input
- Power Switch
- Alarm Input\Output\RS-485 (refer to Alarm Port Pins Definition)
- Video Signal Input:1-16ch video signal input;
- Audio Output:2ch audio signal surveillance and playback output (Remark: 6516A series only)
- Video Signal Input: 1-16ch video signal input;[e3]
- Video Output(Commonly Referred as AV Output):2ch video signal output (Remark: 6516L series only)
- Spot output: output circularly in sequence
- VGA: Connect to computer monitor;
- RS-232: Standard RS-232 port;
- Internet Port: RJ45 port.

### 1.3. Alarm Ports Output View

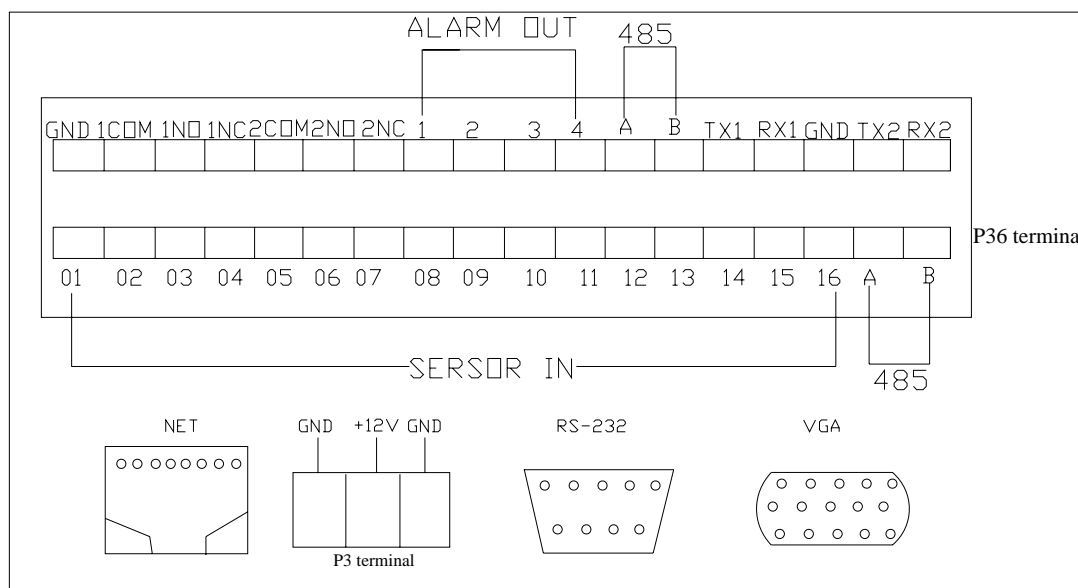

#### 1.3.1 Alarm Port Pins Definition

Pin	Definition	Function Specification	Pin	Definition	Function Specification
Pin 1	IN1	1st Channel Alarm Input	Pin 19	GND	Grounding Pin
Pin 2	IN2	2nd Channel Alarm Input	Pin 20	COM1	Alarm Output 0
Pin 3	IN3	3rd Channel Alarm Input	Pin 21	NO1	
Pin 4	IN4	4th Channel Alarm Input	Pin 22	NC1	
Pin 5	IN5	5th Channel Alarm Input	Pin 23	COM2	Alarm Output 1
Pin 6	IN6	6th Channel Alarm Input	Pin 24	NO2	
Pin 7	IN7	7th Channel Alarm Input	Pin 25	NC2	
Pin 8	IN8	8th Channel Alarm Input	Pin 26	OUT1	Alarm Output 2 (Level Output)
Pin 9	IN9	9th Channel Alarm Input	Pin 27	OUT2	Alarm Output 3 (Level Output)
Pin 10	IN10	10th Channel Alarm Input	Pin 28	OUT3	Alarm Output 4 (Level Output)
Pin 11	IN11	11th Channel Alarm Input	Pin 29	OUT4	Alarm Output 5 (Level Output)
Pin 12	IN12	12th Channel Alarm Input	Pin 30	485A	Reservation
Pin 13	IN13	13th Channel Alarm Input	Pin 31	485B	Reservation
Pin 14	IN14	14th Channel Alarm Input	Pin 32	TX1	Reservation
Pin 15	IN15	15th Channel Alarm Input	Pin 33	RX1	Reservation
Pin 16	IN16	16th Channel Alarm Input	Pin 34	GND	Grounding Pin
Pin 17	485A	PTZ Decoder/Speed Dome A/+	Pin 35	TX2	Reservation
Pin 18	485B	PTZ Decoder/Speed Dome B/+	Pin 36	RX2	Reservation

Remark: Alarm Output 0: Corresponding to 1-16ch alarm input; Alarm Output 1: Corresponding to DVR power break alarm

Alarm Output 2: Corresponding to 1-16ch alarm input; Alarm Output 3: Corresponding to failure alarm;

Alarm Output 4: Reservation; Alarm Output 5 Reservation;

### 1.3.2 Alarm wiring diagram

#### 1.3.2.1 When using the HI/ LO sensor input

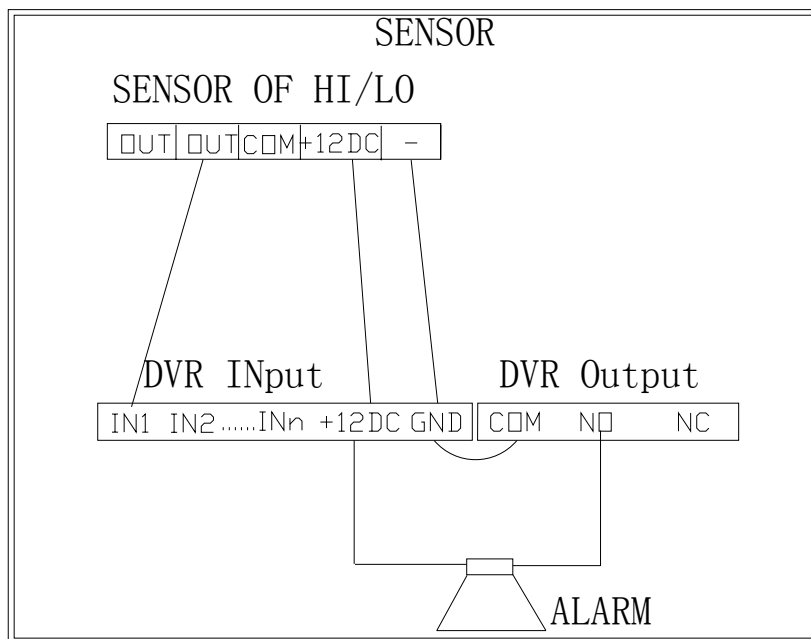

**1.3.2.2. When using the OPEN/ CLOSE sensor input**

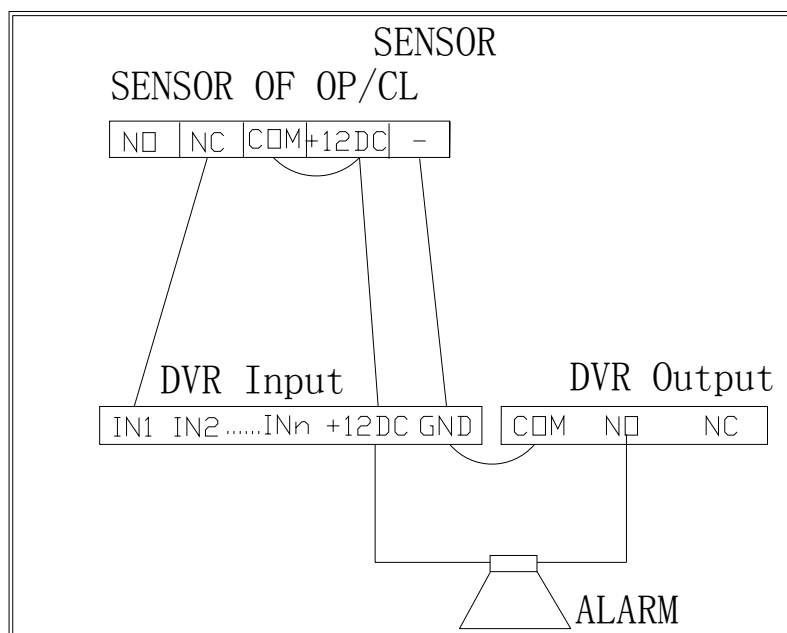

- Remark: Refer with following example steps to activate the alarm sensor function:
- i. In the GUI menu, for SENSOR1, make the sensor "ALARM" setting as "OPEN"
  - ii. Then in the SENSOR1, the "MODE" must be set as "OPEN"
  - iii. "DELAY / OUTPUT" for sensor 1, the I/O Alarm out set as "OPEN"
  - iv. "Motion Alarm Out" set as "OPEN"

## 1.4. Remote Control

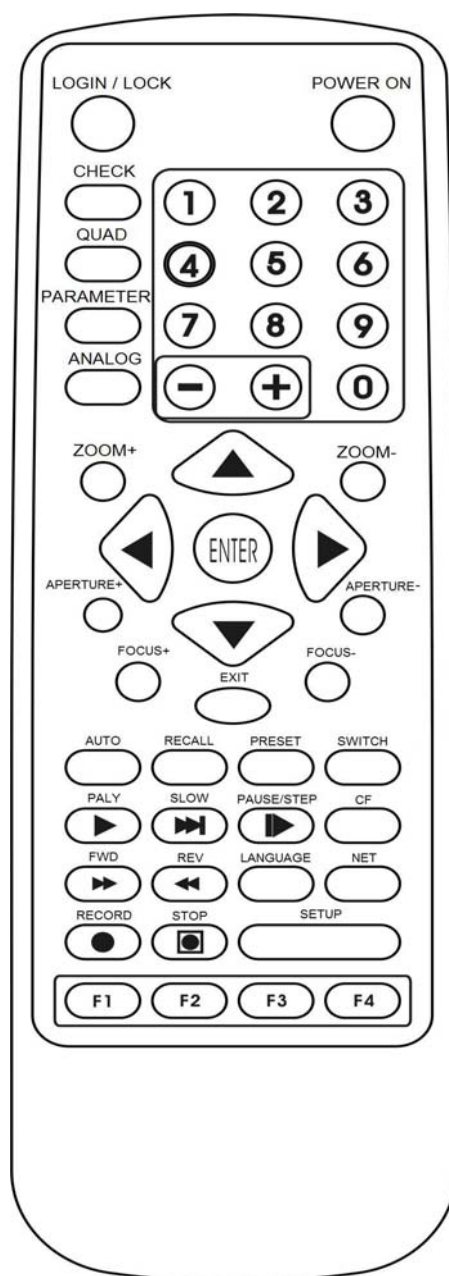

### 1.4.1 Number Keys

**【0-9】Keys:** Number keys, for number input or video changing, press number key 1, 2, 3, 4 to change output display to the 1st, 2nd, 3rd, 4th channel single window screen of the recording while playing;

**【+】、【-】Keys:** For adjusting analog quantity parameters and page up/down while searching for recording data and so on.

### 1.4.2 Menu Operation Keys

- ▲: Upward Direction Key;
- ▼: Downward Direction Key;
- ◀: Leftward Direction Key and REW Key;
- ▶: Rightward Direction Key and FF Key;

**【ENTER】 Key:** System time will display when ENTER Key is selected;

#### 1.4.3 PTZ Control Keys

**【ZOOM+】 , 【ZOOM-】 Keys:** Adjust image zoom;

**【IRIS+】 , 【IRIS-】 Keys:** Adjust image intensity;

**【FOCUS+】 , 【FOCUS-】 Keys:** Adjust image definition;

**【AUTO】 Key:** Auto control;

**【TRANSFER】 Key:** PTZ transfer control;

**【PRESET】 Key:** PTZ preset control;

**【BRUSH/LIGHT】 Key:** Brush and light control;

#### 1.4.4 Player Keys

**【PLAY】 Key: Playback the recording;**

**【SLOW】 Key:** Slow play the image, 1/2x, 1/4x, 1/8x speed; press **【PLAY】** Key to Return to normal speed;

**【Pause】 Key:** Press to pause, press repeatedly, one press one frame, press **【PLAY】** Key to Return to normal speed;

**【FF】 Key:** Fast forward to playback, Forward 1/2 speed, press **【PLAY】** Key to Return to normal speed;

**【REW】 Key:** Reverse to playback, Reverse 1/2 speed, press **【PLAY】** Key to Return to normal speed;

#### 1.4.5 Other Keys

**【ON/OFF】 Key:** For system on or off (standby or on);

**【LOG IN/LOCK】 Key:** Get operating authority, namely to enter password and lock operation;

**【CHECK】 Key:** For checking the data in hard disk, all logs and information of the recorder;

**【IMAGE SWITCH】 Key:** For switching screen between multi windows and single window;

**【CHANNEL PARAMETERS】 Key:** For setting parameters of each channel;

**【ADJ】 Key:** Display the brightness, saturation, contrast, sensitivity of motion detect, adjust the parameters with **【+】** , **【-】** keys;

**【EXIT】 Key:** Escape to the surveillance image directly or Return to upper menu;

**【CF】Key:** Press **【SET】**key to enter CF menu after insert. Select **【BASIC SET】**, enter the **【CF】** Options of the submenu and operate the CF card, details in CF CARD OPERATIONS;

**【LANGUAGE】 Key:** No action;

**【NETWORK】 Key:** No action;

**【REC】 Key:** 4ch manual recording simultaneously while 4 windows screen, 1ch manual recording while 1 window screen;

**【STOP REC】 Key:** Stop manual recording;

**【SET】 Key:** For setting parameters of the system;

**【F1】 Key:** For selecting time quantum while playback;

**【F2】 Key:** Press this key to enter PTZ control setting menu while single channel display.

- Press Leftward, Rightward, Upward, Downward Direction keys to make PTZ camera

leftward, rightward, upward, downward adjustable, press 【ENTER】key to auto move  
Return to the original position;

- 【ZOOM+】 , 【ZOOM-】 keys to adjust image zoom;
- 【IRIS+】 , 【IRIS-】 keys to adjust image intensity;
- 【FOCUS+】 , 【FOCUS-】 keys to adjust image definition;
- 【BRUSH/LIGHT】 key to control brush and light;
- 【AUTO】 key to control automatic;
- 【TRANSFER】 key to PTZ transfer control;
- 【PRESET】 key to PTZ preset control;
- 【F2】 key again to escape from PTZ control setting menu;

### 1.5. Technical Specification data

Item	Device Parameter	Specification / details		
System	UI Language	Simplified Chinese / English		
	User Interface	Icon Operation Interface (OSD Menu)		
	Security	Multi-level Authorities, Multi-level Password		
Video	Video Input	16 Channels Independent Input with 1.0Vp-p, 75Ω BNC		
	Video Output	2ch PAL/NTSC Output with 1.0Vp-p, 75Ω BNC, Composite Video Signal 1ch VGA Display Output		
	Video Display	1/4/8/16 Windows per Screen		
	Video Standard	PAL 25 Frames per Second NTSC 30 Frames per Second	CCIR625 Lines CCIR525 Lines	50Hz 60Hz
	System Resource	16ch Real Time Recording with 1ch Playback and 16ch Surveillance, Online Real Time Surveillance		
Audio	Audio Input	16 Channels Independent Input, 600Ω RCA		
	Audio Output	2ch Surveillance/Playback Audio Output, 600Ω RCA		
	Basic Output	1.0—2.2V		
	S/N	≤-30dB		
	Recording Format	Synchronous with Video		
	Audio Compression	ADPCM		
Digital Processing and	Video Compression	MPEG-4 VBR / CBR		
	Image Format	CIF (352×288 Pixels)	1/2D1 (704×288 Pixels)	D1 (704×576 Pixels)

Storing	Video Standard	ISO14496		
	Audio Standard	ADPCM		
	Video Freq.	12.5K-93.75Kbytes/s	25K-175Kbytes/s	25K-250Kbytes/s
	Audio Freq.	4Kbytes/s		
	Audio Size Rate	14.4Mbytes/hour		
	Video Size Rate	45M-337.5Mbytes/hour	90M-630Mbytes/hour	90M-900MMbytes/hour
	Storage	8 IDE Hark Disks, Support 300G or Larger		
	Image Quality	8 Adjustable Levels		
	Max Frame Rate	25 Frames/second/channel	12.5 Frames/second/channel	6.25 Frames/second/channel
	Resolution	Playback (352×288 Pixels) Real Time Surveillance (704×576 Pixels) VGA Output (720×576 Pixels)	Playback (704×288 Pixels) Real Time Surveillance (704×576 Pixels) VGA Output (720×576 Pixels)	Playback (704×576 Pixels) Real Time Surveillance (704×576 Pixels) VGA Output (720×576 Pixels)
	Data Capture	All duplex		
Alarm	Motion Detect	Independent Setting with Each Channel, with 192 Detect Region for Each Channel and 16 Levels Sensitivity		
	Input	16ch Independent Alarm Input (16ch Level Input)		
	Output	6ch Independent Alarm Output [4ch Level, 2ch Relay Switch Status Output (24VDC /120VAC, 1A)] 1ch Power Failure Alarm Output (Relay), 1ch Other Failures Alarm Output		
	Alarm Input Mode	Open/Close		
Com Port	Serial Port	RS485 Signal, Enable to Connect with the PTZ Decoder without External Converter		
	Serial Port	RS232, Common Serial Port		
	Internet Port	RJ-45 10M/100M Broadband Port		
	Internet Protocol	Support TCP/IP, UDP/IP		

	Internet Transfer Mode	Dial-up, ADSL, ISDN, LAN, MAN
	Browser	Client Soft
Others	Power	AC 220V ( $\pm 20\%$ ), 50Hz ( $\pm 2\%$ )
	Consumption	35W (without Hard Disk)
	Working Temperature	0-50°C
	Working Humidity	$\leq 80\%$
	External Dimensions	440(W) $\times$ 90(H) $\times$ 420(D)mm (without Footpads and Pedestal)
	Weight	14KG (with Hard Disk)
	Clock	Build-in System Clock and Calendar

## 2 System Operations

**Precautions:** Log in before enter menu control interface and put into admin password.  
Machine number: 000; admin password: 88888888

### 2.1 System Open/ shutdown

#### 2.1.1 System Open

Connect with AC power with 220V/110V, turn on the main unit, the red light will turn on while system being boot up.

When system in standby mode, press the [ON/OFF] button in front panel or remote control, the red light will be turn off, then monitor will be activate to show as 16-channel windows status, there will be channel number to indicate each input signal. Also on the top of screen will show the system time, number of hard disk and CF card status also show in center of the screen (there would be alert warning for no hard disk install), all of the information only shown on the screen for 5~6 seconds; There will be count down from 100 to 0 second (shown in red color font), the system will be locked up after the count down to 0 second.

**Notice:** If the device being set for timer record function, there are no need for standby status after the system turn on, the system will go to multi-channel screen;

#### 2.1.2 System Login

While the system being lock-in status, require to press [Login/Logoff] button in front panel or remote control, then the screen will have pop-up window "Unit ID: \*\*\*\*\*; Unit ID: 000" (the sub-menu will shown as bellow) then user need to select, there will be "Password:"

user required key in login password to enter into system; (Only accept for User password or Administrator password)

- 1) While user password key is correctly, there will be shown as message “USER PASSWORD CORRECT”, then user can enter into restrict functional / feature level with the device. (Default password is: 88888888)
- 2) While Administrator password key is correctly, there will be shown as message “ADMIN PASSWORD CORRECT”, then administrator can enter into all functional / feature level with the device. (Default password is: 88888888)

**Remark:**

- **There will be difference with administrator and user level authorization: User can only playback all exist file, however, can not stop with the recording, neither to getting record setup or changing; While administrator can use with all those setup features;**

**While password key is correctly, the count down timing (shown in top right corner) will change from red to green color; this would indicate access with difference operation. There will be 100 seconds operation time allow after every key-in button being pressed before system locked; User will be require to re-enter password to back to operation level once the “LOCK” indicator shown in top right corner; Must key-in unit ID and password to enter into operation system while in LOCK status;**

- **If local recorder has been set to timer recording, and connect to the power when it is the set time quantum to record just right, the recorder will enter multi windows screen status directly without pressing the Standby key to start the recorder.**
- **If you start the recorder without installing hard disk, or the hard disk that has been installed is undetected in the preliminary stage of starting up, buzzer of the digital video recorder will alarm, logging in the system can clear the alarm.**
- **If no current system time displays on the screen, please press the 【ENTER】 key on the remote control or panel and it will appear at once**

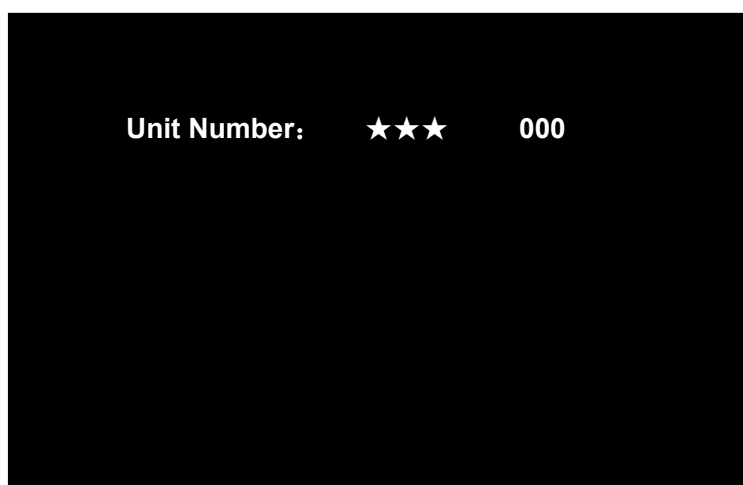

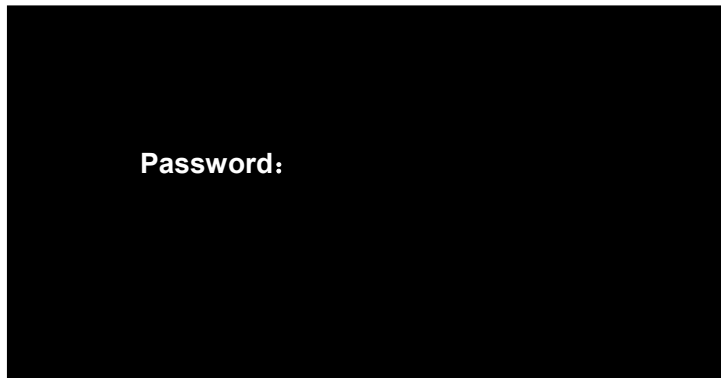
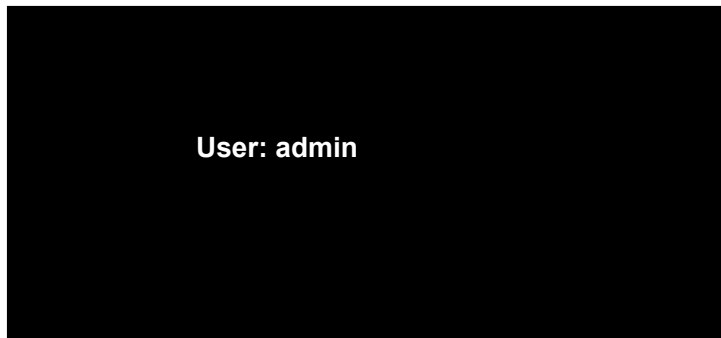

### 2.1.3 System Shut Down

Press [ON/OFF] button in front panel or remote control after the record stop, the system will go into standby mode.

Remark: Please make sure the system status is in standby mode before power off. Avoid any improper operation in here; please do not power off the machine while recording/ playback/ system setting

## 2.2 System Function Settings

System Functions interface includes functions as follows:



The Screen above is OSD main menu of the unit, operate the “▲, ▼, ◀, ▶” keys on the remote control or the panel, select the icon you need (when the icon is selected, the characters below the icon will change into reverse characters), press 【ENTER】, enter the corresponding settings, that will be introduced detail by detail as follows.

### 2.2.1 System setup

Move the cursor to 『System setups』 item (reverse characters mean the item is selected), press 【ENTER】 to enter setting interface of the item, after entering the submenu, move the cursor upward or downward to the item you need to modify. System setups interface is as follows:

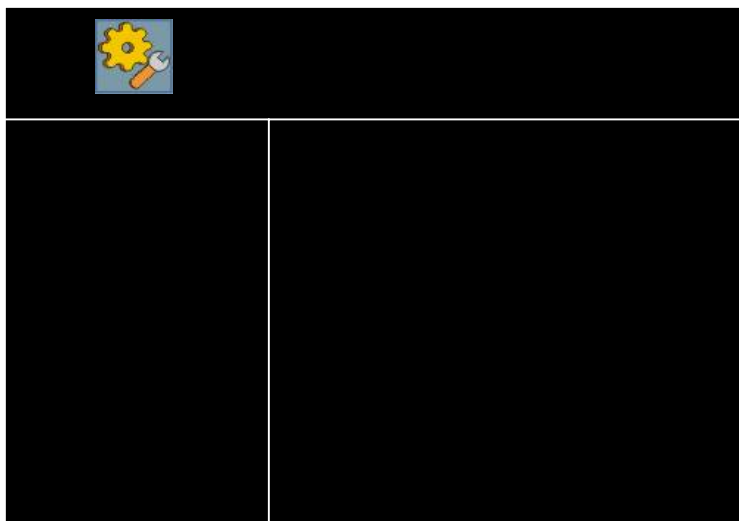

Press direction keys to the item you need, press 『ENTER』 to the settings menu.

#### ■ Date/Time:

You can modify every item of Year, Month, Day, Hour, Minute, Second, 『Week』 is auto modified by the system according to the date you set; move cursor to the corresponding item, press 【ENTER】 to modify or input number to modify directly. While using the number keys to modify the date, you shall only input the last two numbers.

#### ■ Video System:

**PAL** and **NTSC**, press direction keys to the Unit Number, press 『ENTER』 to enter the item, move the cursor to the corresponding item, press 『ENTER』, the item will display “☆”

#### ■ Unit Address:

Input with the **pinyin, capital letter or lowercase letter input methods**, the way is to move the cursor to the item first, press 【ENTER】, enter input status, press 【F3】 key on the remote control to switch the input method. After finishing input, press “ENTER” key again to escape from the input status.

Remark: The input max character size is 8 characters.

#### ■ HDD Overwrite:

Press the direction keys to HDD Overwrite, press 『ENTER』 to the item: Start or Close.

#### ■ Unit Number:

The input range is: any three figures between 000 ~ 999, the factory setting is 000.

#### ■ User Management:

The User Management function is to manage all users of the recorder, such as Password

Function On/Off (only for setting password when start up the recorder), user's authorities and others, the Users Management interface is as follows:

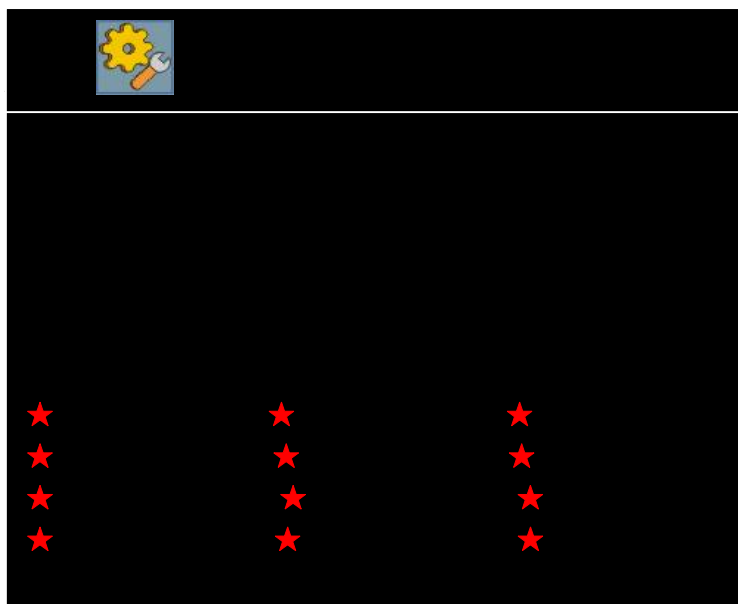

◆ **Password Function:**

As the screen above, move the cursor to 『Password Function』, press 『ENTER』 to select On or Off.

◆ **User:**

admin, user1 ~ user9 all together 10 users' name can be set, the system supports 10 users most, admin user is the default administrator, has all authorities, and the authorities of it cannot be modified; user1 ~ user9 are common users, users with "System setups" authority can assign the authorities of their own.

**Remark: Only "admin" is in effect during the initialization of the system, user1 ~ user9 need the user to enter the item with the administrator identity (admin identity), add and assign the authorities by himself.**

◆ **Password:** Input any 8 characters of numbers as the user's password.

◆ **Re-enter:**

Input 8 characters of numbers of the item above again, confirm the user's password to avoid user's wrong input.

◆ **Authorities Management:** The authorities can be set are:

<b>System Setup</b>	<b>Record Setup</b>	<b>Channel Setup</b>
<b>General Setup</b>	<b>Alarm Setup</b>	<b>Work Task</b>
<b>Network Setup</b>	<b>PTZ Setup</b>	<b>Video Control</b>
<b>Playback</b>	<b>Log Search</b>	<b>Device Info</b>

Total 12 items, different authorities can be assigned according to the different users' usual work. Operating method is: Move the cursor to the corresponding item, press 『ENTER』, the item will display "☆", meaning that authority has been assigned to the user. After setting return to the user's password and authorities, move the cursor to 『Return』 and press 『Enter』 to save and the upper menu.

## 2.2.2 Record Setup

Recording Parameters settings include some setting of the channel, move the cursor to 『Recording Parameters』 item (character background color turning white means the item is selected), press 【ENTER】 to enter setting interface of the item, after entering the submenu, move the cursor upward or downward to the item you need to modify.



- **Channel:** there are 01 to 16 and All 17 choices, press “+”, “-” or 【ENTER】 on the remote control to select.
  - **Record:** 『Valid/Invalid』 two choices can be selected, if 『Effective』 is selected, recording has been set in **Work Tasks**, so recording is on namely it is effective.
  - **Image Quality:** “1-8” total 8 levels. Move the cursor to the item needed, press 【ENTER】 to modify the **parameter** of the item, the smaller the number is, the better the image quality is.
  - **Frame Rate (fps):** For NTSC, there are 02, 04, 08, 15, 30 five frame rate; For PAL, there are 01, 03, 06, 12, 25 **five** frame rate; press “+”, “-” or 【ENTER】 on the remote control to select.
  - **Resolution:** “D1, HD1, CIF” three levels can be set. Move the cursor to the item needed, press 【ENTER】 to modify the parameter of the item  
 D1 (704\*576): Reach the resolution of DVD image;  
 HD1 (704\*288): Reach the resolution of SVCD image;  
 CIF (352\*288): Reach the resolution of VCD image.
  - **Bit Rate:** Move the cursor to the item needed, press 【ENTER】 to switch the Bit Rate while system is recording: VBR, CBR.  
 VBR: Variable bit rate  
 CBR: Committed bit rate
- Audio:** On/Off can be set;  
 Select Return, Return to the upper menu;
- Remark:** **Frame Rate (fps), resolution, Encoded Mode** three items are set by group, (while PAL, channel 1-16: every four channels a group, first group: 1-4, second group: 5-8; third group: 9-12; fourth group: 13-16. Frame rate,

resolution, encoded mode of every channel in a group is the same. After setting the parameters in the interface, judgments should be done as follows:

- PAL:** D1 Total resource of every group is  $\leq 25$  frames  
 HD1 Total resource of every group is  $\leq 50$  frames  
 CIF Total resource of every group is  $\leq 100$  frames
- NTSC:** D1 Total resource of every group is  $\leq 30$  frames  
 HD1 Total resource of every group is  $\leq 60$  frames  
 CIF Total resource of every group is  $\leq 120$  frames

**Remark:** When two channels of D1 or HD1, only channel one and two are in effect

### 2.2.3 Channel Setup

Channel Settings include some setting of the channel, move the cursor to 『Channel Settings』 item (characters background color turning white means the item is selected), press 【ENTER】 to enter setting interface of the item, after entering the submenu, move the cursor upward or downward to the item you need to modify. Channel Settings interface is as follows



- **Channel:** Press keys of number or ENTER or +/- keys to select any item among 01-16 or "All".
- **Title:** Screen Display name, you can input 8 letters, move the cursor to the item first, press 【ENTER】 , and the interface will change as follows:



Then select the letters you need.

■ **Screen Display:**

『On/Off』 two choice for user, when 『On』 is selected, channel's name will display on the surveillance image; if it is closed, channel's name won't display on the surveillance image. Time Insertion

■ **Time Insertion:**

『Upper /Bottom/None』 three choices for user; when 『Upper』 is selected, time will be overprinted on the upper of the image of the corresponding channel by the system; when 『Bottom』 is selected, time will be overprinted at the lower of the image of the corresponding channel by the system; when 『None』 is selected, time won't be overprinted on the screen.

**Remark:** The system will overprint the time to the code off corresponding channel, namely, the time information overprinted to the channel, can't be seen on the surveillance image. Only when play returns the recordings, the time information overprinted can be seen.

**If user need to see the system time in the surveillance status, please press 『ENTER』 on the remote control or panel of the unit, the system time will display on the upper part**

■ **Masking:**

『On/Off』 two choices for the user, press 【ENTER】 to switch between the items. Image Mask is that the fixed zone of the image in channel is Masked, in order to avoid being recorded to the image data (white shield frame instead), to satisfy the special requirements, e.g., avoiding the image of password zone of the safe box being recorded.

**Remark:** Image Masking only affects the code of the channel Masking namely, after Masking zone is set, the covering effect is also on the surveillance image. The covering effect will be show while play return the image data of the channel (a white shield frame is instead of the zone covered).

On the interface of 『Channel Parameters Settings』, move the cursor to the Channel item to select 『Off』 to close the channel which need to be Masked, press 『ENTER』 on the remote control or panel, the system will switch to the single window screen surveillance mode, press 『ENTER』 on the remote control or panel again, and there is a small white square “□” will display on the center of the surveillance screen, the square is a mark of confirming the two vertexes of the cover zone. The covering method is two points positioning method, use the direction keys on the remote control or front panel, move the small white square to the position of the first vertex, press 『ENTER』 to confirm the position of the first vertex, at this time, another small white square will display on the center of the image, move the square to the diagonal position of the first vertex, press 『ENTER』 to confirm, a zone covered will appear, press 『EXIT』 to Return to the interface of 『Channel Parameters Settings』. At this time, 『Off』 of channel cover will auto switch to 『On』 item, it means setting succeed, and it is activated. Press 【ENTER】 again, it will switch to 『Off』, stop the channel cover.

**Remark: 1. While set the rectangular cover zone, multi cover zones can't be set in every channel, only one continuous zone can be set.**

**2. Screen Display, Clock Overprinting is set by group, screen display and clock overprinting is the same of every channel in a group;**

### 3. Channel Image Cover can be set individually.

#### 2.2.4 General Setup

The General Setups include some settings of the equipment such as: hard disk, USB, CF card, disc-carving recorder, move cursor to the 『General Setup』 item (reverse characters mean the item is selected), press 【ENTER】 to enter setting interface of the



option, after entering the submenu, move the cursor upward or downward to the item you need .

##### ■ Default:

Default means default setting before shipment .Move the cursor to the item, press ENTER to the interface of Default. press ENTER to apply; if you want to cancel, select Cancel item to Return to the upper menu

##### ■ HDD Format:

Format hard disk, you can select number 1-9, 9 stands for CF card, after selecting the hard disk you want to format, press Enter to the next confirm menu to format the hard disk; press Cancel to Return to the upper menu.

##### ■ USB:

USB operation is for finding HDD of DVR in PC.

First, connect DVR to PC via USB cable which attached in the accessory case.

Operation in DVR as below:

Enter into the USB menu, there are four groups of hard disk to select, each group include two HDD For example, “group 1” means the first and second HDD which connected to the first IDE. select the item, and press 【ENTER】. Don't exit. Then the USB icon will pop-up at the bottom of the PC, it shows that the USB connection successful.

**Remark:** After USB operation, the system will restart.

##### ■ CF card/DVD:

Exact specifications for the function and operation of CF card and CD are in “CF Card Upgrade and Operation and CD Operation” part of the manual. Turn to Chapter 5.2.4.

### 2.2.5 Alarm Setup

Alarm Setups include some setting related alarm, The interface is as follow.

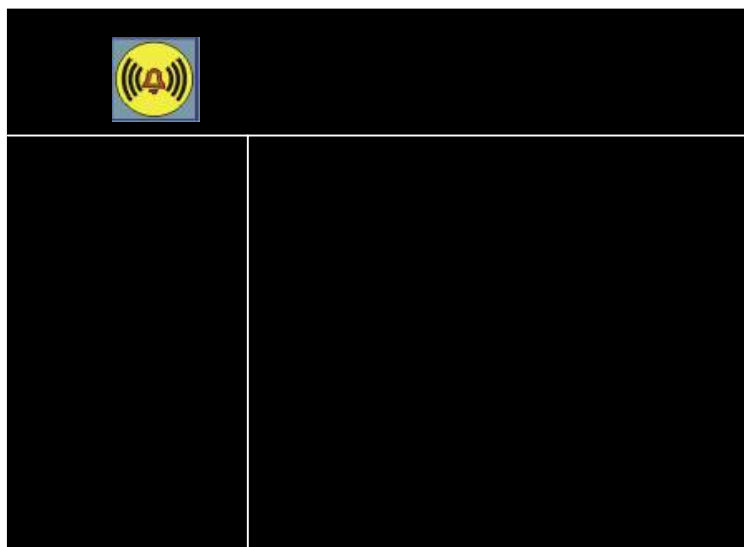

- **Input Mode:** 『N.O/N.C』 two choices for port, two mode standing for I/O alarm input signal, set according to the external equipment which trigger alarm signal.
- **Duration:** It means time duration of recording after the trigger is over. (120 ~ 300 seconds)
- **Output Delay:** The retaining time span in output signal state of alarm linkage status when alarm signal, if the alarm output port is connected with alarm lamp, alarm bell and other alarm equipment. Output delay is the time span of the alarm lamp, alarm bell started.
- **Alarm Delay:** It means the time duration the buzzer after the trigger is over
- **Buzzer:** It's built in the recorder, when there is some error with the device or signal triggered by SENSOR. It will alarm. "ON/OFF" can be set;
- **Buzzer Delay:** When Buzzer is set as ON, Buzzer delay means the time duration for alarm when there is some error with the device or signal triggered by SENSOR.
- **Video Loss:** If set as ON, When video signal is missed, the buzzer will alarm, and "Video loss" will display on the screen; "Off" means: the buzzer won't alarm, but only display Video loss on the screen.
- **HDD Error:** It means whether need trigger alarm when there is some wrong with the HDD inside DVR.  
**Remark:** The condition for alarm when HDD error is that the system can find the hard disk.

### 2.2.6 Work Task

Work Tasks include settings of recording plan and the zone of motion detection of every channel, the interface is as below

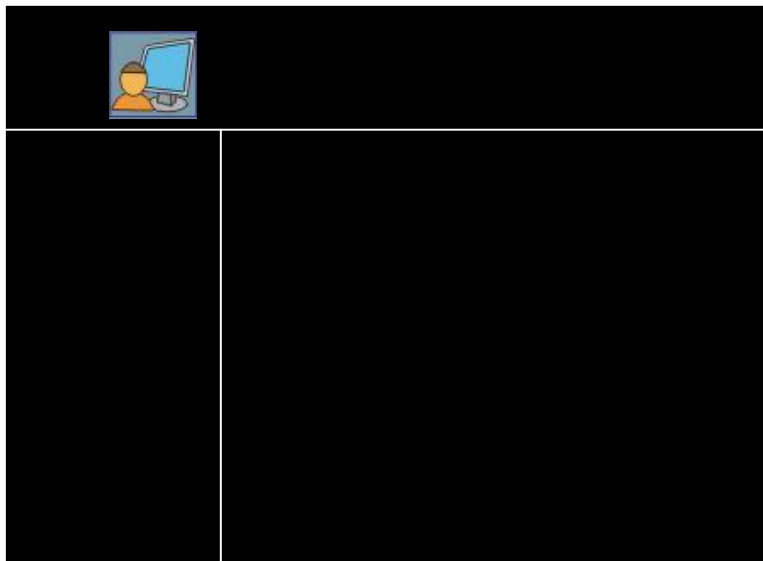

- **Schedule:** it means options related recording for each channel, there are three items, Date/Period/ Type.

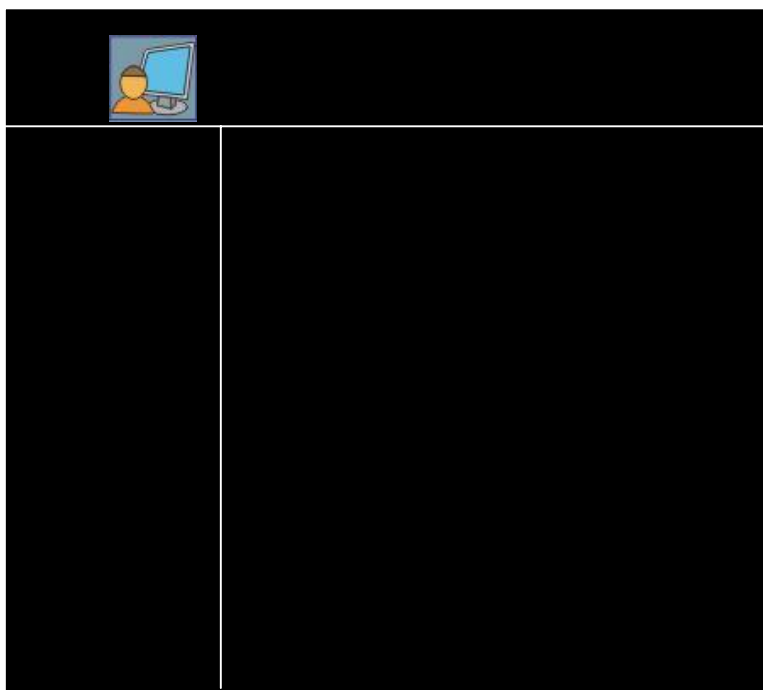

- ◆ **Channel:** Press 【ENTER】 or +/- keys to select any item among 01-16 or “All”. Select **All** to set 16ch to do quickly.
- ◆ **Date:** 『Everyday/Monday ~ Sunday/\*\*\*\*\*』 eight choices for user, 『\*\*\*\*\*』 means no date, user can switch among the choices through 【ENTER】 or +/-.
- ◆ **Period:** Set the recording period of time.  
**Tip:** Date can be multi-item, for satisfying requirement of multi-period recording in the same date  
**Remark:** the first period must be earlier than the second period.
- ◆ **Mode:** 『Timing/Motion/Alarm』 three options for selecting, press 【ENTER】 to

switch among the items. 『Timing』 means it is always recording during the period in this channel; 『Motion』 means when there is object moving in the detect zone, system will start to record in a regular time, if no object moving, it won't record; 『Alarm』 means when the channel receive external I/O alarm trigger signal, system will start to record in a regular time, no external I/O alarm trigger signal, it won't record.

- ◆ **Copy:** Copy the settings of current channel to another. Operation Method: Press 【ENTER】 or +/- keys to set the period of time first, select the channel needed to copy and the channel you want to copy to, then select Copy. After coping, press Return to Return to the upper menu.
- **Power saving:** Press +/- or ENTER to select date and time, 『Everyday/Monday ~ Sunday/\*\*\*\*\*』 eight choices for user, while the rush period has been set, press power switch on the rear panel without pressing the 『ON/OFF』, that's tosaustem won't be standby and enter the recording status directly in the rush period (if it is set to record in this period of time) when the power is connected
- **MD Area:** Press 【ENTER】 to enter the interface when the red cursor points to the 『MD Area』, as follows

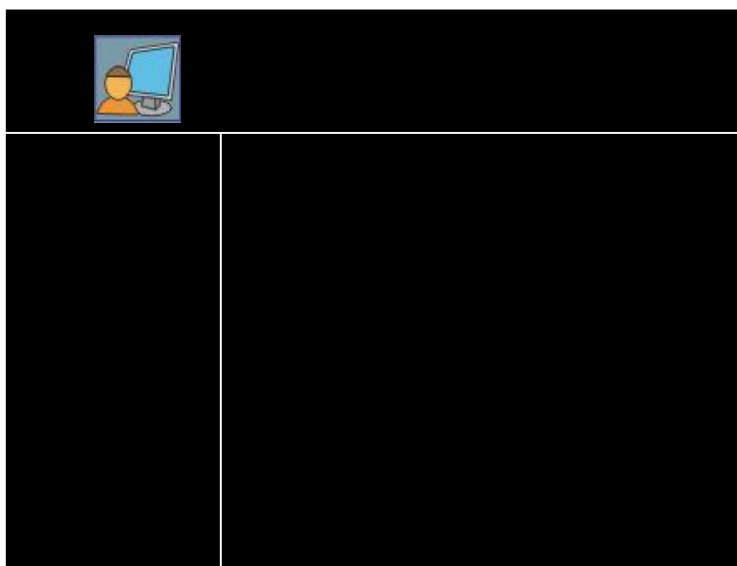

As the view above, select a channel to set. Press 【ENTER】 to enter the setting interface of Effective Zone:

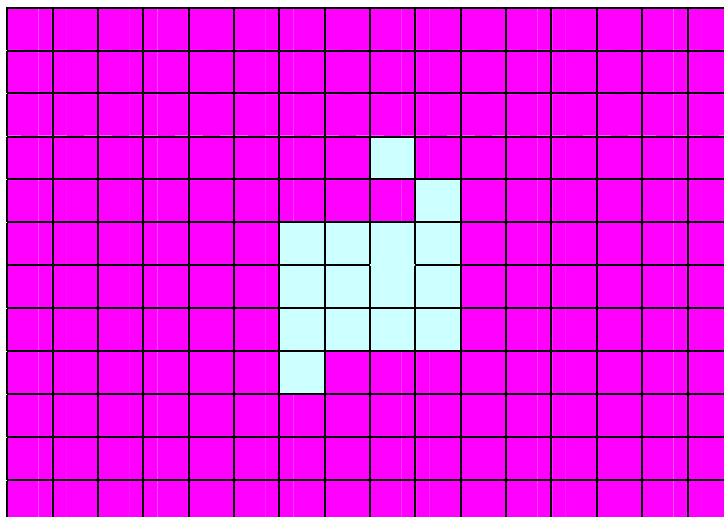

The view above is made up by 16×12 little zones. Light purple zones stand for the zones which are not selected, transparent zones stand for the zones that are selected. Operating method is: enter the setting interface, there will be a small inlaid square on the screen, press **【ENTER】**, and the purple small square will turn transparent, it means that the zone is selected, press the direction keys on the remote control or panel, the small square will move among the zones, and the zones will be selected, press **【EXIT】**, Return to 『Work Tasks』 interface, zone settings succeed.

- **Packing Time:** There are 3 options, 30,45,60 minutes press **【ENTER】** to select.
- **Video Output:** There are two options, Main output is when output device is connected to 'Video output' of the real panel; However, spot output is available when output device is connected to 'Spot output' of the real panel:  
Interval (s). Time period for playing each channel, after the period, the picture will change to another channel. There are 12 options, as 5/10/15/.../60s  
Mode: Quad/Octo

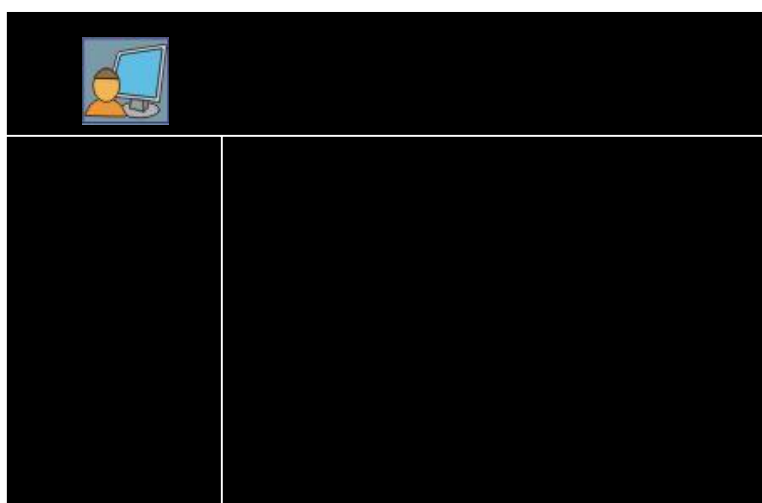

- **Video Alarm:** When alarm triggered by some sensor, the system will switch to the corresponding channel. If there are several sensor triggered alarm at the same time, the picture on live view will switch to the last corresponding channel.

### 2.2.7 Network Setup

There are three options related network,the interface is as below:

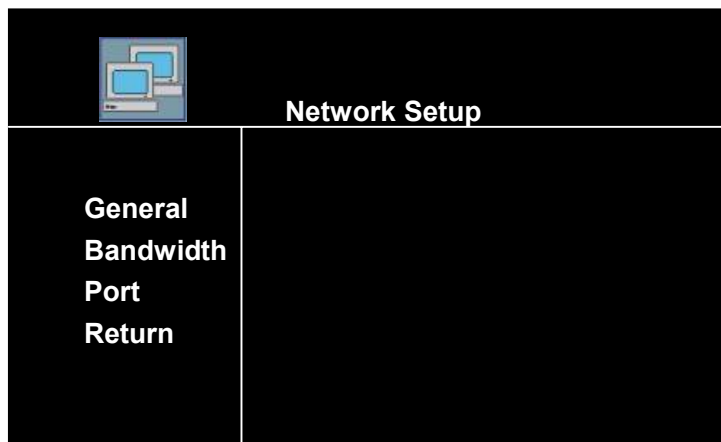

- **General:** For IP address, subnet mask and gate way.

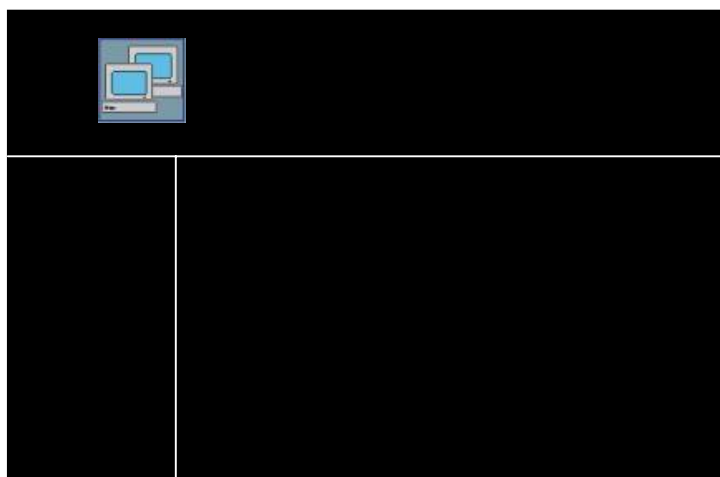

**Remark:** The view above is the interface of Regular Settings when the administrator uses the password 88888888 (eight 8) to log in, if administrator uses super password to log in, MAC Address will be added to the interface of Regular Settings, as follows:



- ◆ **IP Address:** According to the internet the host in, set the IP Address correctly.
- ◆ **Subnet Mask:** According to the LAN the host in, input the subnet mask correctly.
- ◆ **Gate Way:** According to the IP address setting.
- ◆ **MAC Address:** Be sure the first field of MAC is 000.if client software can't connect the DVR correctly, please check the MAC address. The other field can be any numbers between 1 ~ 254.
- Move the red cursor to 『Bandwidth Settings』, press 【ENTER】 to enter the interface:

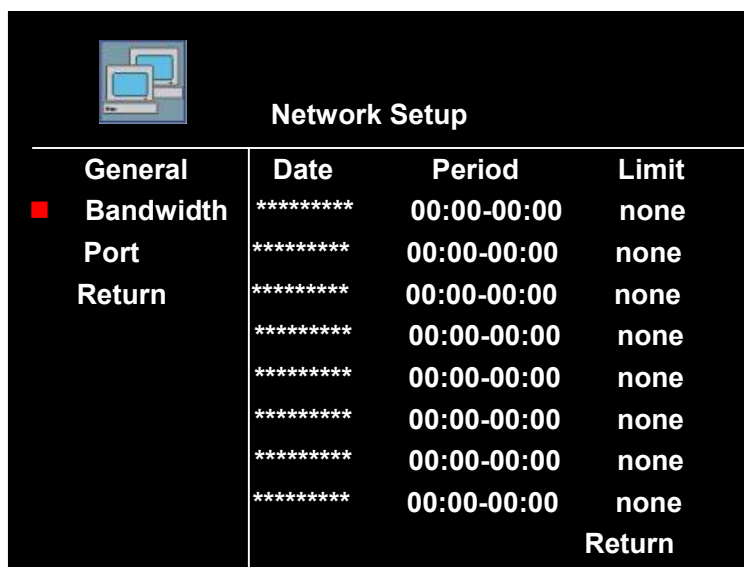

**Date:** 『Everyday/Monday to Sunday/\*\*\*\*\*』 eight choices for user, 『\*\*\*\*\*』 means no date, user can switch among the choices through 【ENTER】 or +/-key.

- ◆ **Period:** Set the period of time of the bandwidth limit.  
**Tip:** Date can be multi-item set repeatedly, for satisfying requirement of multi-period recording in the same date  
**Remark:** When you set the recording period, time in front of “——” must be earlier than the time behind “——”.E.g. Setting as follow is wrong: “13:00——11:30”.
- Bandwidth Limit:** There are five choices, they are: Limitless, 384K, 512K, 1M, 2M.

### 2.2.8 PTZ Setup

Move the cursor to 『PTZ Settings』, press 【ENTER】 to enter the interface of PTZ control of 16 channels.

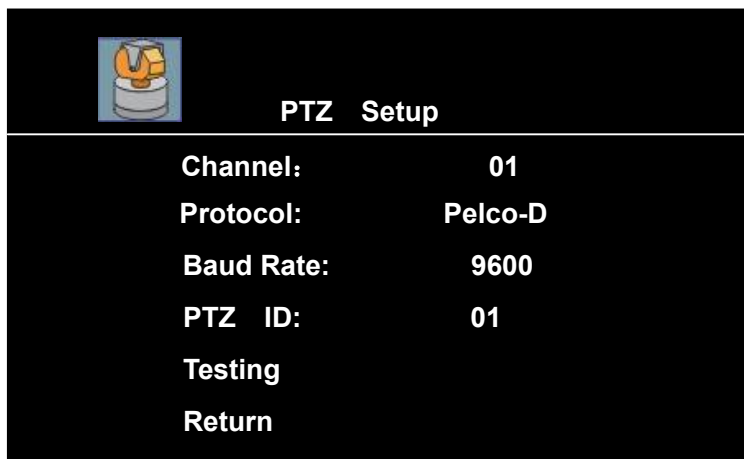

- **Channel:** It stands for 1-16, All total 17 choices of the channel number.
- **Protocol:** It stands for the communication protocol between the system and the decoder. Move the cursor to the item, press **【ENTER】** , “+” or “-” key, you can select different protocols (Pelco-P / Pelco-D / DSCP / Pelco03 ~ Pelco15), only the protocol selected matches the protocol of the decoder, you can operate the front end unit;
- **Baud Rate:** It stands for the communication speed between the system and the decoder. Move the cursor to the item, press **【ENTER】** , “+” or “-” , key you can select different bit rate ( 1200/2400/4800/9600 ) , only the bit rate selected matches the bit rate of the decoder, you can operate the front end unit;
- **PTZ ID:** Move the cursor to the item, press **【ENTER】** , “+” or “-” , key, you can select different PTZ number ( 01-63 ) , 01 is corresponding to the first address code of the decoder, namely address code “00”.
- **Test:** Select **Test**, enter into single CH screen, you can test PTZ of every channel.  
**Remark:** Parameters of PTZ Protocol, Baud Rate, PTZ ID, The three items should be the same as the parameters of PTZ (speed dome).
- ⊙ **Operation of PTZ:** After correctly setting the parameters of PTZ, press **【F2】** on the remote control or **【PTZ】** on the panel in the single window screen surveillance (PTZ indicator is on), “channel X : PTZ Control” characters display on the top left corner of the screen, you can operate the PTZ of the channel through remote control or panel at this time.
  - 【▲】** , **【▼】** Keys: Len move upward, downward, display characters: PTZ Up, PTZ Down;
  - 【▲】** , **【▼】** Keys: Len move leftward, rightward, display characters: PTZ Left, PTZ Right;
  - 【ZOOM+】** , **【ZOOM-】** Keys: Adjust image zoom, show characters: ZOOM+, ZOOM-
  - 【IRIS+】** , **【IRIS-】** Keys: Adjust image intensity, show characters: IRIS+, IRIS-;
  - 【FOCUS+】** , **【FOCUS-】** Keys: Adjust image intensity, show characters: FOCUS+, FOCUS-;
  - 【AUTO】** Key: Auto control, show characters: AUTO;
  - 【TRANSFER】** Key: PTZ transfer control, show characters: TRANSFER 00;
  - 【PRESET】** Key: PTZ transfer control, show characters: PRESET 00;
  - 【BRUSH/LIGHT】** Key: Brush and light and other auxiliaries switch control; show characters: BRUSH;
 Press **【F2】** or **【PTZ】** again, to escape from the PTZ operation, Return to single window surveillance status; switch the surveillance image,  
**【F2】** Key: Operate PTZ of another channel.

**Remark 1:** System doesn't manual recording functions while operating the PTZ.

**Remark 2:** If system starts to record (timing or alarm start), and the image will switch to four windows surveillance screen while operating the PTZ, but it won't affect the PTZ operating.

**Remark 3:** If PTZ can not be operated regularly, please check the RS-485 link (refer to “Alarm Port Pins Specification”) and parameters of PTZ Settings.

### 2.2.9 EXIT

Move the cursor to the item, press **【ENTER】**, namely save the settings and escape the setting menu, Return to the surveillance image.

**Tip: All interface of System setups, only when [Return] is selected, you'd better select this item, you can save the settings in the page precisely. If you don't select the item, press 【EXIT】 on the remote control or panel directly, the system will Return to the surveillance image directly, and you can't save the settings.**

## 3 Check Operations

After logging in, press **【CHECK】** key to enter the querying menu, press direction keys to select the options needed, press **【ENTER】** key to enter the item.

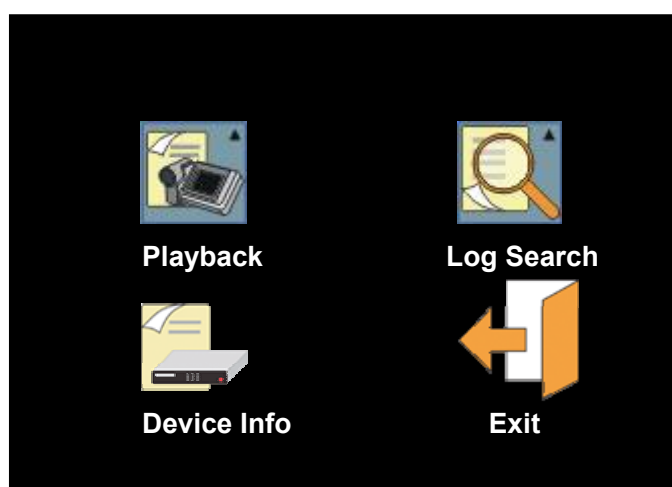

### 3.1. Recording Data

Move the cursor to **『Records』**, press **【ENTER】** key to enter the submenu. Press **【ENTER】**, **“+”**, **“-”** keys to select the recording Channel or Date and Time to check the item at this time (as the following view).

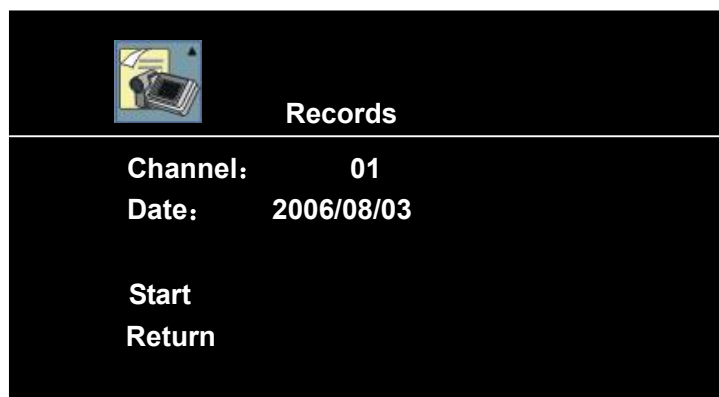

Move the cursor to “Start”, press **【ENTER】** key to the state of hard disk searching, after searching the system will auto enter the submenu (as the following view).

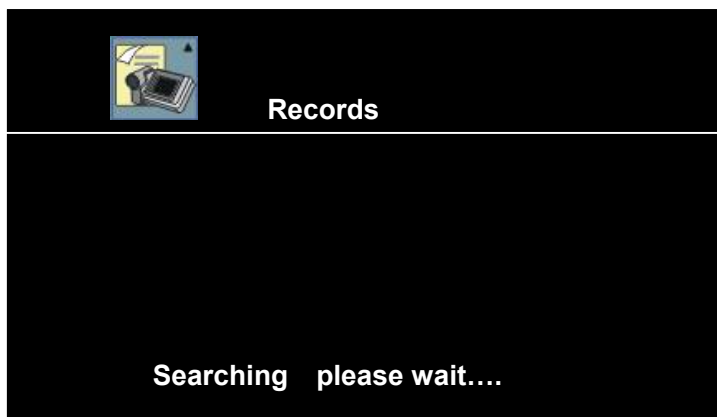

The recording data of the channel and date selected display in the submenu, you can move the cursor upward or downward to select different date, press “+”, “-” key to move the cursor upward, downward to page up and page down and select the recording period of time, press **【ENTER】** key to check the data, data of which date is printed yellow is the intraday recording data.

If there is no data of the date selected, “No Data That Day” will display on the screen. Recording data of some dates can’t display all in a page, move the cursor to “Up”/ “Down”, press **【ENTER】** or “+/-” to page, you can check the data page by page.

Recording data section of the view above, “1” stands for the video data is recorded in hard disk 1, “20060410” displays the name of the file (named by Year, Month and Day). “01:00-02:00” displays the start and stop time, “D1” displays the image quality, and “06” is frame rate.

- **Name:** Address name of the channel;
- **Period:** Every recording time (Packing Time) of data of all recording periods of time,

is max 60 minutes.

- **Resolution:** D1, HD1, CIF three levels, stand for which definition the video data is.
- **Frame Rate:** When the system is set to PAL, the frame rate is divided into five levels i.e. “25, 12, 06, 03 and 01”. When the system is set to NTSC, the frame rate is divided into five levels i.e. “30, 15, 08, 04 and 02”. The levels stand for use which frame rate to record the image data.

Move the cursor to the item you need to check, press **【ENTER】** key or PLAY key to enter the playback image.

**Remark:** 1. Press 1, 2, 3 and 4 keys to switch the recording data among all channels of the group while playback, such as:

Press number 2 while the recording data 01: 00——02: 00 is playing back, the system will give a hint:

“Switching to the channel 02, please wait...”, then recording data of the same time of channel 02 will appear.

2. If Clock is set to on in the Channel parameters before, the clock while recording will display on the playback image;
3. If Clock isn't set in the Channel parameters, the clock while recording can display if **【ENTER】** key is pressed. At this time, press **【F1】** key to select time quantum to playback; press **【SLOW】** key to playback in low speed of 1/2×, 1/4×, 1/8×; press **【FF】** key to fast forward playback in forward 1 and forward 2 speed; press **【REW】** key to reverse playback; and press **【STILL/F.ADV】** key to playback frame by frame. Press **【EXIT】** key to escape from the playback image, Return to the previous menu.
4. After recording of this period of time has been played, recording data of next period will be auto played.

### 3.2. Log Search

Move the cursor to 『Log Search』 item, press **【ENTER】** key to enter the submenu. Press **【ENTER】**, “+” or “-” key at this time to select the type of log need to check (**All Log, Alarm Log, Motion Log, Access Log**) (as the following view).



After selecting, move the cursor to “Start”, press **【ENTER】** key to enter the submenu, such as select the Parameters **Log**, the interface is as following:

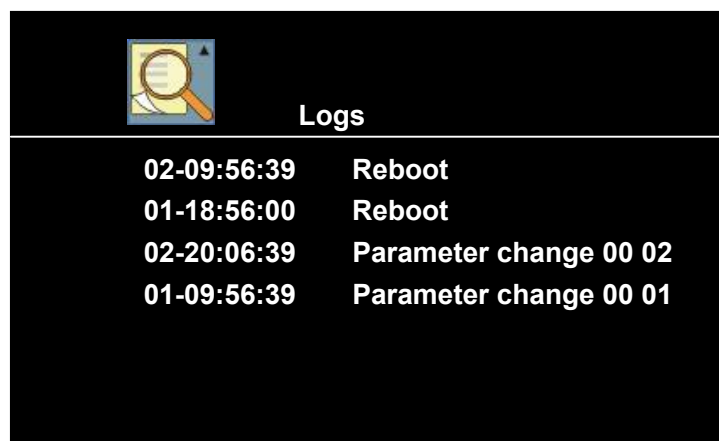

The log data of the type of log is display in the submenu, the time at which the log happened was recorded in every log.

**Remark:**

- When select “All Log” to check, all records of three types of log will display.
- Access Log means what are accessed, including a. Parameters Change, b. Restart, c. Manual Recording, f. Format Hard Disk, g. Reset Settings.
- Alarm Log means what matters cause the alarm, such as: Password Error (input three times of wrong password repeately); Video Missed; Hard Disk Failure.
- Motion Log record the matters of motion detect, including the time,channel,matter and motion detect mark while motion detecting.
- When no log of the item selected, blank page will display on the screen. Recording data of some dates can't display all in a page, press **【ENTER】**key or “+/-” key to turn the page, you can check the data page by page.

### 3.3. Device Info

Move the cursor to 『Device Info』, press **【ENTER】** key to check **Channel Status, HDD Information and Version number of firmware.**

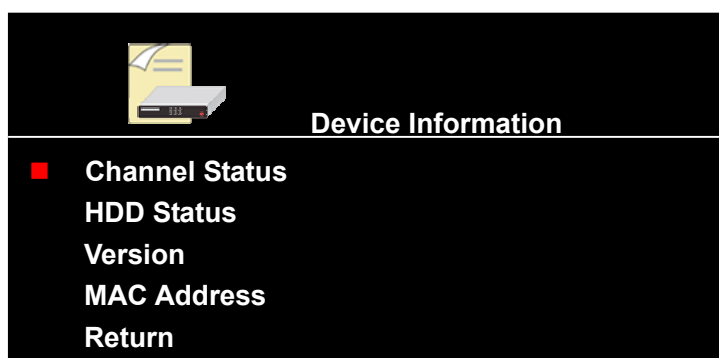

- ◆ **Channel Status**, it means recording Status, Image Quality, Resolution, Frame Rate of **each** channels .Interface is as the following:



**Device Information**

■ CH Status	CH	Status	Quality	Resolution	Rate
HDD Status	1	REC	1	CIF	30
Version	2	Idle	2	CIF	30
MAC Add	3	REC	1	CIF	30
Return	4	REC	1	CIF	30
	5	REC	1	CIF	30
	6	REC	1	CIF	30
	7	REC	1	CIF	30
	8	REC	1	CIF	30

Page Down      Return

◆ **HDD status**, including Capacity and Remained Capacity of 8 HDD.



If you select **Version** and press **【ENTER】** key to enter the interface, **Version** number will display on the screen.



**Device Information**

CH Status	Version: 6516E-A-01.000
HDD Status	
■ Version	
Return	

**Remark:** The view above is the interface of Device Info when the administrator uses the password 88888888 to log in, if administrator uses super password to log in, MAC Address will be added to the interface of Device Info.

### 3.4. EXIT

Move the cursor to this item, press **【ENTER】** key to confirm, Return to the surveillance image.

## 4 Other Operation

### 4.1. CF Card Operation

#### 4.1.1 Update By CF card

The CF card brand we recommend is KINGSTONE series  
Format CF card to FAT32 first, copy the update program of the soft from PC to CF card. Disconnect the power of DVR, insert the CF card with update program to the CF card slot of front panel, press **【ENTER】** key or **【ON/OFF】** key without release, connect the power, after 10 seconds, the Channel and Power LED are blinking, that means the recorder is updating, release your hand; After about one or two minutes, update succeed. Take out the CF card after disconnecting the power of DV. Restart the recorder .

#### 4.1.2 Other Operations of CF Card

If you want to operate the CF card, please disconnect the power of the recorder , insert CF card to the CF slot, restart the recorder .

After logging in, in the status of **stopping recording**,

- a. Press **【Setup】** key on the panel or remote control to enter the interface of **Settings**,
- b. Go to **General setup**. Select **CF card/DVD** option,
- c. Move cursor to “**CF Card**”, press **【ENTER】** key to enter submenu of “**CF Card**”:

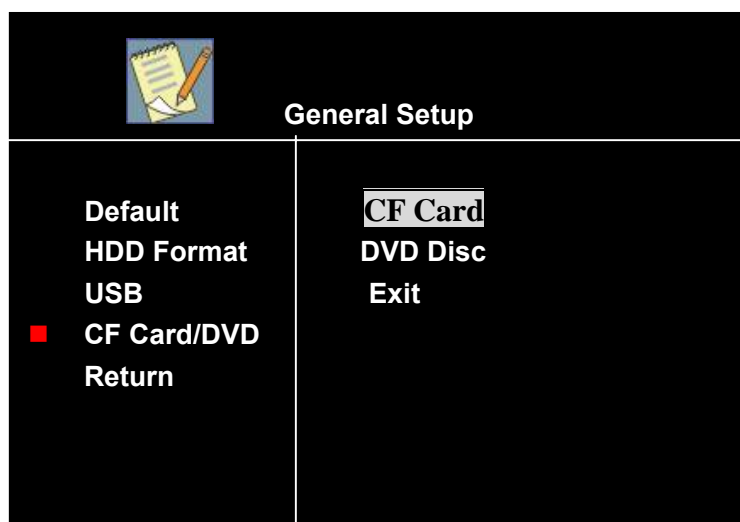

You can do a series of other operations of CF card, including **Copy Information**, **Playback Data**, **Update Settings** and **Backup Data** (see the following sections).

#### 4.1.2.1 Backup Data

If you need to Backup the recording data of the HDD to the CF card, move the cursor to “COPY”, press **【ENTER】** key to copy the recording data, details are as below:

- **Part of Recording file Bankup:**

Move the cursor to “**Bankup**”, press **【ENTER】** key to enter into the **Recording Data**

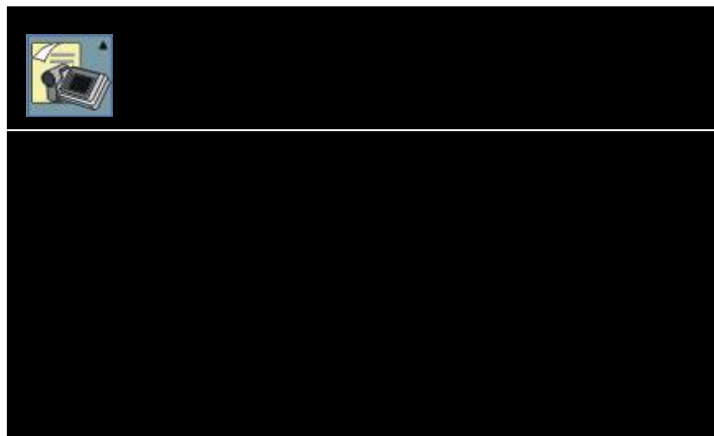

And then **find out** the video data needed to Backup (including Channel, Date and Time can be selected), select a channel (select **01** as view) to enter the interface in which all recording data of the channel display:

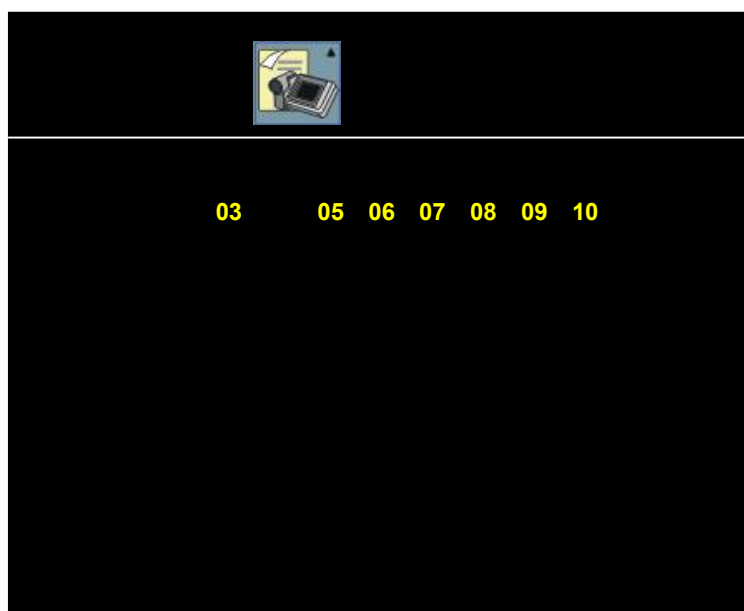

After selecting the recording date, period of time, press **【ENTER】** key ,to playback the recording file. If you want to playback, press **【CF】** key on the remote control or panel immediately, “Copying...” will display, it means it is copying; if copying complete, press **【CF】** key on the remote control or panel to stop copy, “Copying...” will disappear. So the video data Backup to the CF card completely.

- **Full Recording Data Bankup:**

Move the cursor to **Backup**, press **【ENTER】** ,find out file need to bankup and move

cursor to the file, press 【CF】 , “Please Press Again to Confirm” will display on the left bottom screen ,view as following:

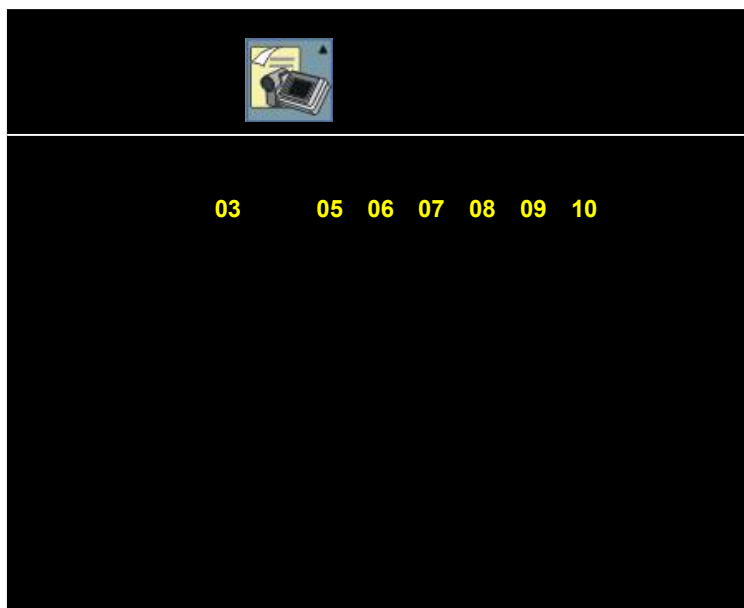

Press 【CF】 again, if the capacity of CF card is smaller than the capacity of the period of time, “unavailable” will display; if the capacity of CF card is not smaller than the capacity of the file, “Copied: Completed Percentage” will display. When it finishes, it will display: Copy succeed.

**Remark: Please ensure there is enough capacity of CF card before backup.**

**4.1.3 Playback**

Move the cursor to “**Playback**”, select the file in CF card, then press ENTER to playback. If there is no content in the CF card, No Record will display in the interface of CF Card Data Playback.

**4.1.4 Copy Information and Update Settings**

In order to set multi DVR as the same settings quickly ,you can do this operatin, Backup the settings of one system to the CF card, then update the settings on the other device . This function can copy all settings of the recorder to “CF card”.

**4.2 CD Operation**

**The feature is optional, please make sure DVR has DVD built-in before CD operation**

After enter into the CF card/DVD menu, select DVD disc:

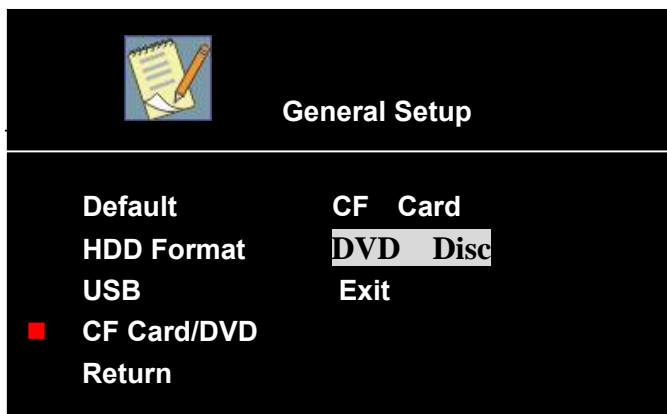

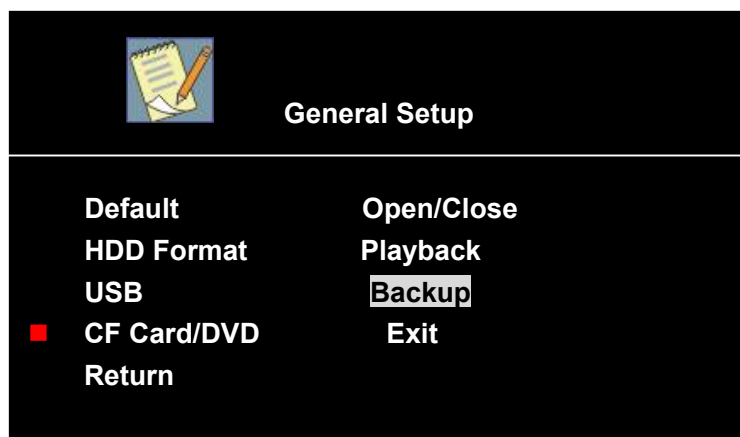

In this menu, also you can do playback and backup operation. The operation step is similar with that of operating CF card.

### 4.3 Analog Quantity Adjustment

Adjust analog quantity when monitor in 1 window.(system under stop recording status)

- **Brightness:** press **【adjust】** and then **【-】**, **【+】** to enter into this setting, then **【-】**, **【+】** to increase or reduce
- **Saturation:** press **【adjust】** and then **【-】**, **【+】** to enter into this setting, then **【-】**, **【+】** increase or reduce.
- **Definition:** press **【adjust】** and then **【-】**, **【+】** to enter into this setting, then **【-】**, **【+】** increase or reduce.
- **Color:** press **【adjust】** and then **【-】**, **【+】** to enter into this setting, then **【-】**, **【+】** increase or reduce.

### 4.4 Recording and Playing

#### 4.4.1 Recording:

- Recording by hand  
press **【Recording】** to start up16 channels recording  
press **【stop】** to stop recording by hand.
- Time select recording  
According to details of **【working task】**
- Alarm recording  
According to details of **【working task】**

#### 4.4.2 Playing

Play all the recording、recording by hand、timing record、MD record、alarm record. And

##### 4.4.2.1 Select time playing

**【F1】** :Time select while in playback

Input time (must be double figure) and play

Remark: the input time must be valid, for example, file period is in 10: 00 – 11: 00, the input time must be set within 10: 00 – 11: 00.

##### 4.4.3 Stop Playing

press **【stop】** on panel or **【exit】** on remote control could stop playing and go back to the previous interface.

#### 4.4.4 Play slow

**【Slow】** :Play slower than normal speed press it and go into the slow state

“×1/2”、“×1/4”、“×1/8”、“play” available. [Play] for resume at normal play

#### 4.4.5 Pause and step

**【Pause/step】** :Stops the playback mode

when in playback, every time press **【Pause/step】**,the frame will forward one frame. [play] for resume at normal play

#### 4.4.6 FWD/REW

**【FWD】** :Fast forward, X2, X4 speed available, [play] for resume at normal play

**【REW】** : Fast backward, X2, X4 speed available, [play] for resume at normal play